

ALUMINIJASTA VHODNA VRATA

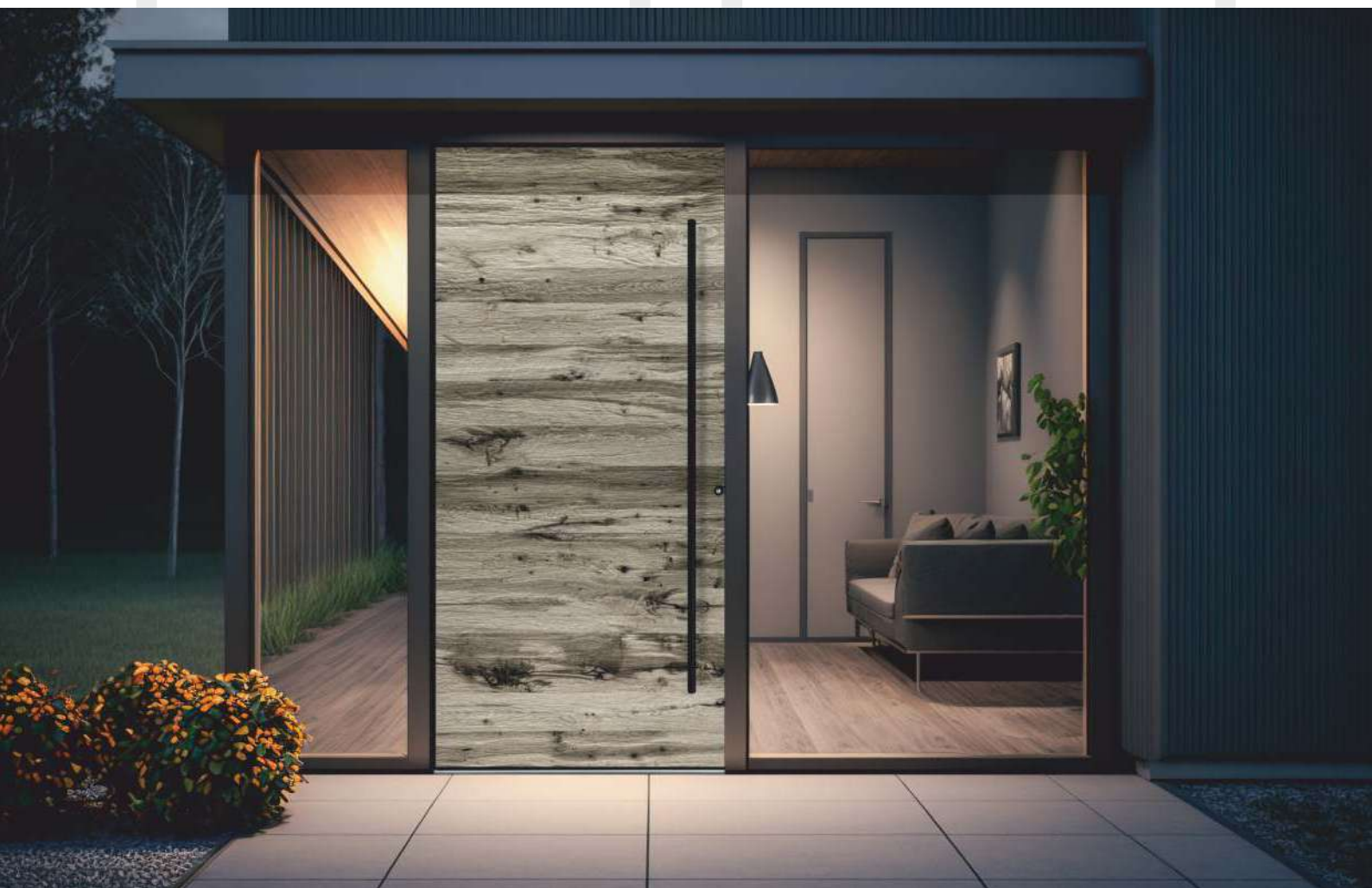

inles[®] OKNA
VRATA

TREND

New Forest

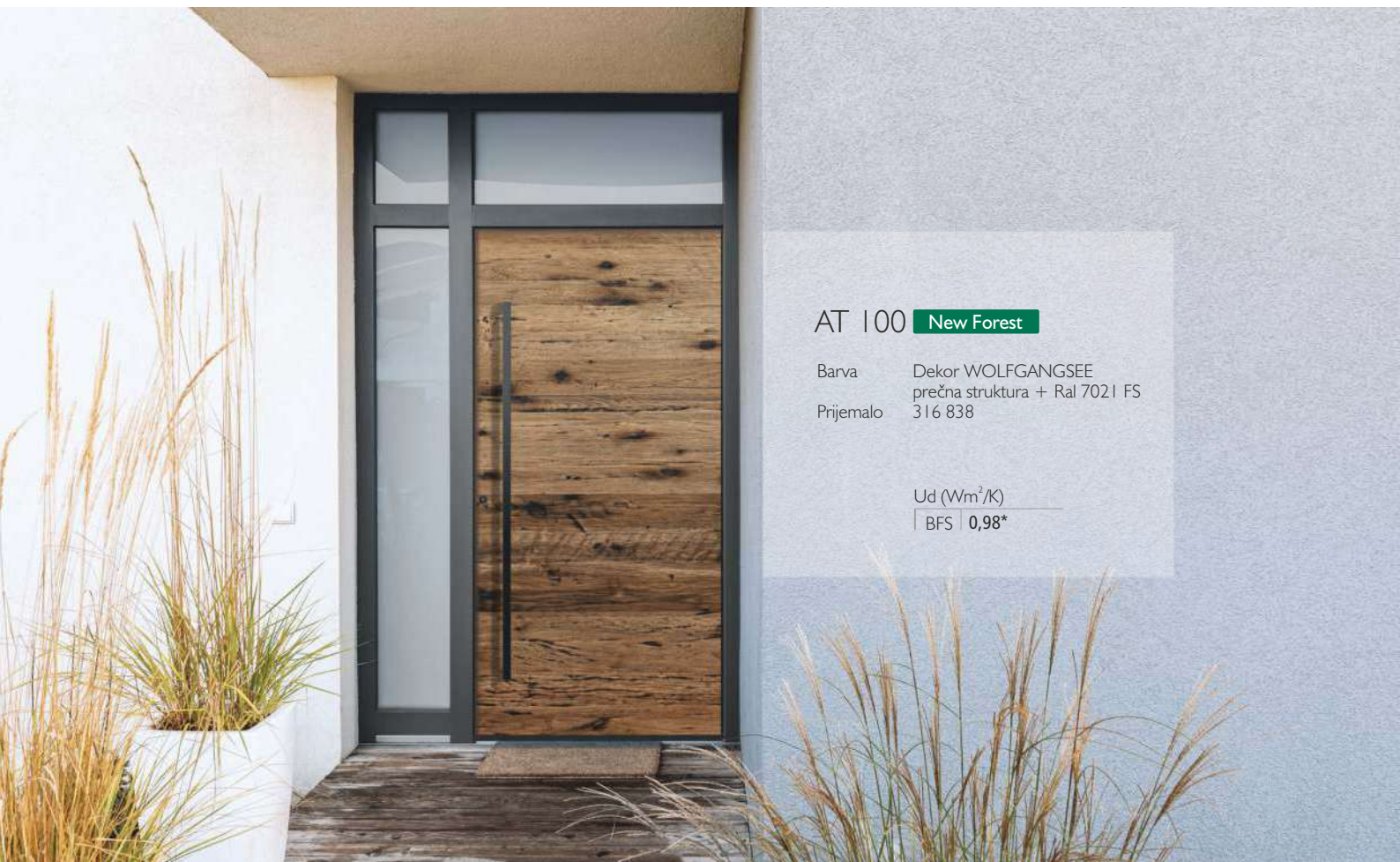

AT 100 **New Forest**

Barva Dekor WOLFGANGSEE
prečna struktura + Ral 7021 FS
Prijemalo 316 838

Ud (Wm²/K)
| BFS | 0,98*

Vhodna vrata so izdelana v sistemu ADS 95AK.SI, v obojestransko prekrivni izvedbi krila. Zunanja stran krila je prekrita s furnirjem, ki prinaša toplino lesa in unikatno strukturo vsakih vrat. Na voljo v petih različicah furnirja.



AT 100 **New Forest**

Barva Dekor MONDSSEE
prečna struktura + Ral 9005 FS
Prijemalo 316 838

Ud (Wm²/K)
| BFS | **0,98***



AT 100 **New Forest**

Barva Dekor TRAUNSEE
prečna struktura + Ral 9005 FS
Prijemalo 316 838

Ud (Wm²/K)
| BFS | **0,98***

AT 100 **New Forest** /AST 100A

Barva Dekor ALTAUSSEE
prečna struktura + Ral 9005 FS
Steklo orn. Satinato belo
Prijemalo 316 838
Odpiranje na prstni odtis

Ud (Wm²/K)
| BFS | **0,98***

SISTEM ADS.SI

- ☐ Profil okvirja iz aluminija debeline 75 ali 95 mm ravnih ali zaobljenih linij. Profil krila iz aluminija je debeline 85 in 75mm.
- ☐ Na sredini profilov za okvir in krilo je termo člen, ki izboljša toplotne karakteristike profila.
- ☐ Polnila iz trde PUR pene oblečene v aluminij z dobrimi toplotno izolativnimi karakteristikami.
- ☐ Pri izvedbah z obojestransko prekritim krilom brez stekelnega izreza ter dimenziji vrat 1100 x 2100 mm, se dosega toplotna prehodnost vrat $U_d = 0,84 \text{ W/m}^2\text{K}$, pri enostransko prekritih alu vhodnih vratih se dosega vrednost $U_d 1,2 \text{ W/m}^2\text{K}$.



OKOVJE

- ☐ Kakovostna in praktična nasadila.
- ☐ 5-kratna zapora krila standardno.
- ☐ Razne opcije odpiranja- odpiranje navzven, odpiranje na prstni odtis, električno odpiranje, ...

ZASTEKLITEV

- ☐ Na izbiro imamo široko paleto toplotno in zvočno izolativnih ter varnostnih stekel.
- ☐ Velika izbira ornamentev in vitražev tudi po vaših željah.
- ☐ Dodelava stekla z različnimi folijami, steklenimi dodatki, peskanjem, ...



POVRŠINSKA OBDELAVA

- ☐ Prašno lakiranje površin je ekološko prijaznejše in zagotavlja odlično kakovost ter obstojnost obarvane površine.
- ☐ Široka paleta aktualnih standardnih barv.
- ☐ Širok izbor strukturnih ali gladkih barvnih površin aluminija, barve po Ral barvni karti ter imitacije lesnih dekorjev.

ODPIRANJE

Opiranje navznoter, pogled od **zunaj**



DIN LEVO



DIN DESNO

PREGLED TIPOV

odpiranje navznoter, pogled od **znotraj**

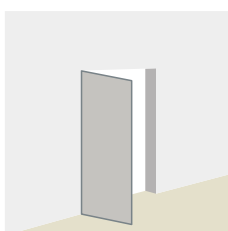

Tip 01

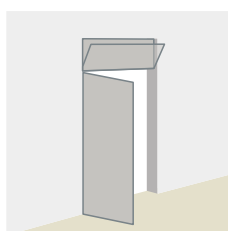

Tip 02/03

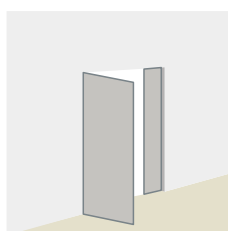

Tip 04

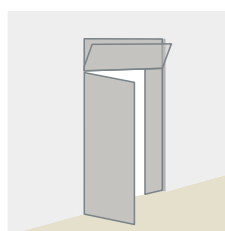

Tip 05/06

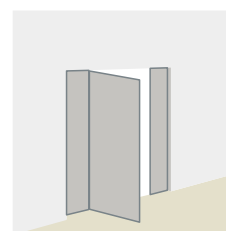

Tip 07

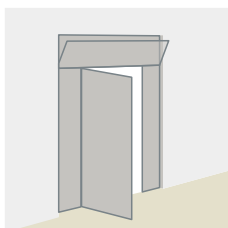

Tip 08/09

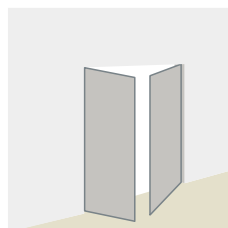

Tip 21

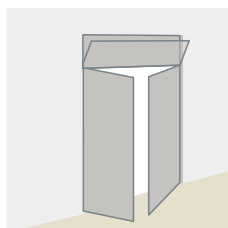

Tip 22/23

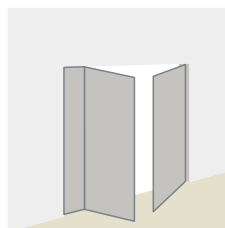

Tip 24

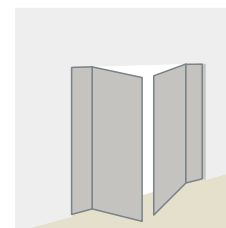

Tip 25

Aluminijasta vhodna vrata **zunanja stran**

Model AT 100, sistem ADS 75B.SI

poravnana

Barva: krilo Dekor Altholz (Stadelholz-IN), prečna struktura

Okvir: Cast Iron Fs Metallic



Les/ aluminij okno **zunanja stran**

INO-HA80-MM poravnana

INO-HA80-F poravnana

Barva Alu: Cast Iron Fs Metallic

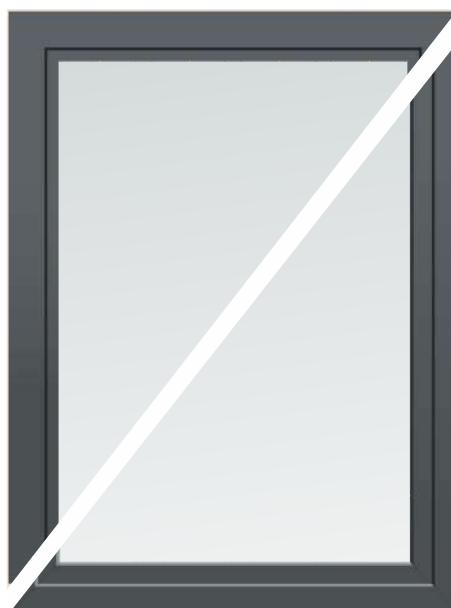

PVC/ aluminij okno **zunanja stran**

Living Top Alu - standardna izvedba

Barva Alu: Cast Iron Fs Metallic

BEDIENUNGSKOMFORT



Odpiranje na prstni odtis
s čitalcem DLine



Odpiranje na prstni odtis
s čitalcem Idencom



Prijemalo SG 124
s čitalcem dLine



Smart unilock
tipkovnica

Aluminijasta vhodna vrata **notranja stran**

Model AT 100, Sistem ADS 75B.SI

poravnana

Barva: krilo in okvir: Cast Iron Fs Metallic

Les/ aluminij okno **notranja stran**

INO-HA80-MM **poravnana**

INO-HA80-F - standardna izvedba

Barva Holz: DB 703



PVC/ aluminij okno **notranja stran**

Living Top Alu - standardna izvedba

Barva PVC: Mattex Shine dark graphite



LED OSVETLITEV



Prijemalo z Led-osvetlitvijo,
z zaščito pred praskami
in aplikacijo iz nerjaveče pločevine



LED-Diode

DIGITALNO KUKALO



LCD



ADS 95AK.SI

oglata oblika okvirja

obojestransko prekrivno krilo

Ud = 0,81 W/m²K

(Ud vrednost velja za velikost vrat 1230 x 2180 mm, brez izreza za steklo)

Ud = 0,84 W/m²K

(Ud vrednost velja za velikost vrat 1230 x 2180 mm, brez izreza za steklo)



ADS 95.SI

okrogla oblika okvirja

troslojna
zasteklitev

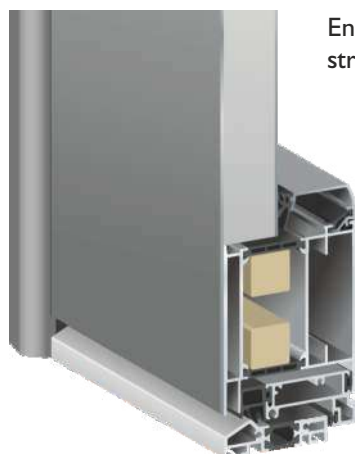

Enostransko - na zunanji strani prekrivno krilo

Ud = 1,2 W/m²K

(brez izreza za steklo)



Izvedba z vidnim okvirjem na krilu

Pri teh modelih so okvirji kril vidni, tako znotraj kot zunaj.

Na voljo so v vseh različicah vhodnih vrat, razen v seriji Refined, New Forest in Deluxe.



ADS 75B.SI

poravnani okvir s krilom
na zunanji in notranji strani

Ud = 0,83 W/m²K

(Ud vrednost velja za velikost vrat 1230 x 2180 mm, brez izreza za steklo)

Ud = 0,87 W/m²K

(Ud vrednost velja za velikost vrat 1230 x 2180 mm, brez izreza za steklo)

obojestransko prekrivno krilo

Ud = 0,81 W/m²K

(Ud vrednost velja za velikost vrat 1230 x 2180 mm, brez izreza za steklo)

Ud = 0,84 W/m²K

(Ud vrednost velja za velikost vrat 1230 x 2180 mm, brez izreza za steklo)



ADS 75.SI

poravnani okvir s krilom
samo na zunanji strani

IZVEDBE ZASTEKLITVENIH LETVIC

OVR

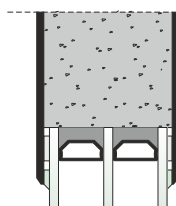

Serija TREND

EVR enostransko

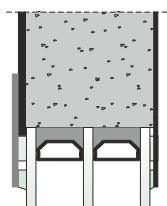

Serija DELUXE
(standardno)

EVR obojestransko

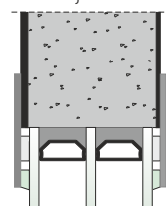

Serija DELUXE

AVR

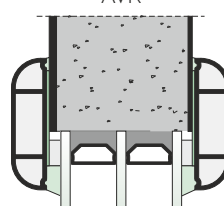

Seriji MODERN, CLASSIC

SVR

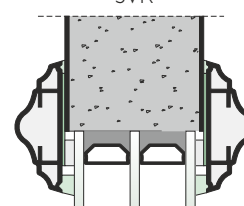



RC2 – visoka stopnja varnosti

Varnost nepremičnine je bila in ostaja pomemben dejavnik pri izbiri aluminijastih vhodnih vrat.

Aluminijasta vrata poleg visokega kakovostnega standarda že serijsko vključujejo **5-točkovno zaklepanje (zapahi in vrtljivi zatiči)**, kar zagotavlja dodatno zaščito.

Na voljo so tudi v **certificiranih varnostnih razredih RC I in RC2**.

Za še večjo prilagodljivost lahko izbirate med dodatnimi, naprednimi rešitvami zaklepanja ter individualno opremo, ki povečuje udobje uporabe.



RC2 AUSFÜHRUNG

1 VARNOSTNI ZATIČI



2 VARNOSTNO STEKLO P4A



3 OMEJEVALEC DVIGA KRILA



4 VARNOSTNI CILINDER Z ZAŠČITO PROTI PREVRTANJU

5 VARNOSTNA GARNITURA



3 TRODIMENZIONALNA NASADILA



4 POHODNI PRAG

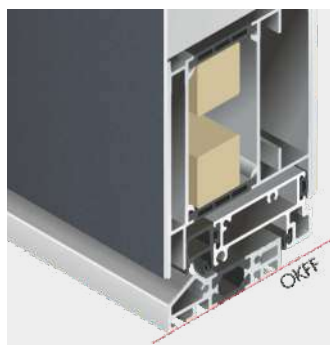

FP1 (standard)

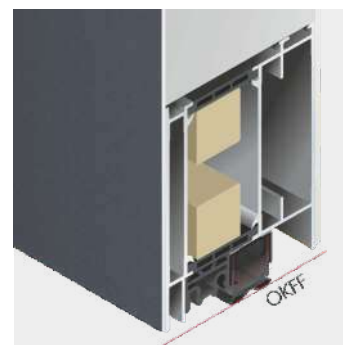

FP5 avtomatsko tesnilo



ATVE 5
5-kratna ZAPORA
 - iz nerjaveče pločevine,
 z varnostnimi zatiči
 in kavliji

osnovna varnost
 serijsko

Mehanski večtokovni sistem zaklepanja, pri katerem osnovno ključavnico in dodatne zapirne elemente (kavelj in varnostni zatič) poslužujemo s pomočjo ključa cilindra



ATVK 5
5-kratna ZAPORA s komfort funkcijo
 - iz nerjaveče pločevine,
 z varnostnimi zatiči
 in kavliji

Mehanski večtokovni sistem zaklepanja (kavelj, varnostni zatič)
 - Z notranje strani je vedno omogočeno odpiranje s kljuko, tudi v primeru zaklenjenih vrat (komfortna funkcija)

- Obvezen prostovrteči cilinder

- Možna samo izvedba kljuka/ bunka ali držalo/ kljuka

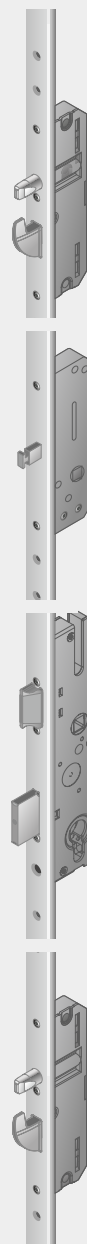
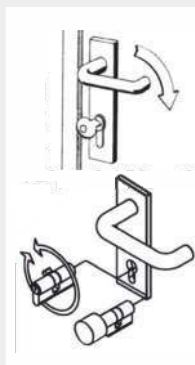

ATVS 5
5-kratna ZAPORA
 - iz nerjaveče pločevine
 Z varnostnimi zatiči, kavliji
 ter varnostnim vratnim lovilcem

Sistem večtokovnega zaklepanja (kavelj, varnostni zatič) in varnostnega vratnega lovilca, ki dopušča le režno odpiranje vrat za nekaj cm, tako da ne more vstopiti nepovabljen gost

Od znotraj se vratni lovilce upravlja z vrtljivim gumbom, od zunaj pa s ključem preko glavne ključavnice.



ELEKTRO-ODPIRALO



SKRITA NASADILA



Za vrata z odpiranjem navznoter
 - 100° kot odpiranja



Za vrata z odpiranjem navzven
 ter za sistem ADS 75B.SI
 - 180° kot odpiranja



ATVE A
5-kratno varnostno zaklepanje vrat AVTOMATSKO, MEHANSKO

Avtomatsko večtočkovno zaklepanje z integrirano samonastavitvijo.

- 1 Vedno zanesljivo varno. Da so vrata vedno zanesljivo zaklenjena, je vgrajen avtomatski sprožilni zapah.
- 2 Dnevno odklepanje: odhod iz hiše brez ključa. Praktično za vse vsakodnevne situacije, ko želimo objekt za kratek čas zapustiti brez ključa: preprosto izklopite avtomatsko funkcijo s pomočjo drsnika za dnevno odklepanje in sprostite zapah glavne ključavnice na okvirju.

ATVE A-M
5-kratno varnostno zaklepanje vrat AVTOMATSKO, z motorno funkcijo vklj. napajanje

- Zaklepne elemente je mogoče mehansko zakleniti.

- Odklepanje preko domofona, biometrije ... (zapah glavne ključavnice ne sme biti predhodno zaklenjen)

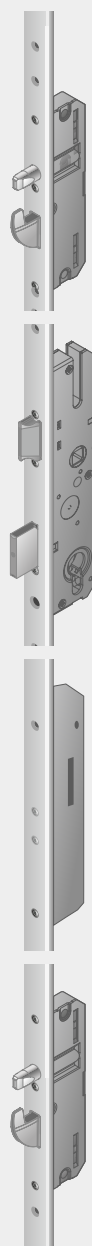

ATVS 5EA
5-kratna zapora Genius

Nerjaveča pločevina, vključno z napajalnikom, z elektromehanskim pogonom, profilni cilindri s prostim tekom z zaščito proti vrtnanju in varnostno funkcijo, vključno s 6 ključi. Pozor: uporabljajte izključno cilindre z oznako FZG!

Ko so vrata zaprta, se v nočnem načinu samodejno zaklenejo z motorjem (pribl. 3 sek.). Vsi obstoječi zaklepni elementi se iztegnejo. Vrata je mogoče odkleniti ročno s cilindričnim ključem ali samodejno preko zunanjega sistema kontrole dostopa.

Ko so vrata popolnoma zaklenjena, je prav tako mogoče od znotraj s kljuko umakniti vse zaporne elemente in tako vrata hitro odpreti.

CILINDRIČNI VLOŽKI



Cilindrični vložek z dvostranskim varnostnim delovanjem in 6 ključi (standardno)



Cilindrični vložek z zaščito proti prevrtanju in 6 ključi



Prosto vrteč cilindrični vložek z zaščito proti prevrtanju, z dvostranskim varnostnim delovanjem in 6 ključi

SISTEM KONTROLE DOSTOPA (ATVE A-M, ATVS 5EA GENIUS)



dLine



dLine črne barve



Smart unilock

Smart unilock je inovativna tipkovnica, ki združuje odpiranje preko mobilne aplikacije, prstnega odtisa, kode ali RFID v enem izdelku.



Idencom

Aluminjasta vhodna vrata **zunanja stran**

Model AT 894, Sistem ADS 95AK.SI

Barva: Cast Iron Fs Metallic, HD Walnuss dunkel

Hišna številka - nerjaveča pločevina

HIŠNA ŠTEVILKA
- MOTIV NA STEKLU



KUKALO



Medenina polirana / satinirana krom

ZUNANJA OKROGLA ROZETA



Nerjaveča pločevina (standard) črna

ODKAPNA LETEV



Različni sistemi pisemskih nabiralnikov



WSE 03, Nerjaveča pločevina kot aplikacija



WSE 01, Nerjaveča pločevina



WSE 02, Nerjaveča pločevina

Aluminijasta vhodna vrata **notranja stran**

Model AT 894, Sistem ADS 95AK.SI

Barva: Ral 9016 FS

Vratno zapiralo TS 5000



NOTRANJA PRIJEMALA IN ROZETE



Nasadila

Notranje kljuke I200

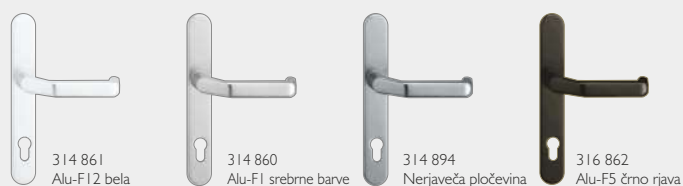

VTOPLJENA PRIJEMALA

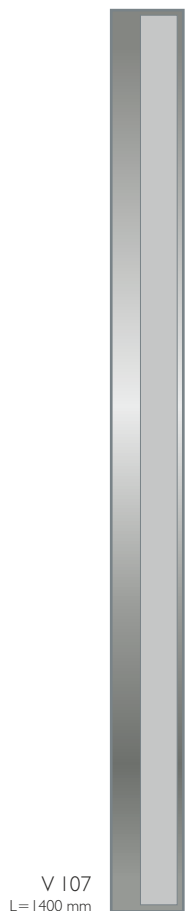

GS-113



GS-88

STOßGRIFFE



SG-49

VTOPLJENO PRIJEMALO

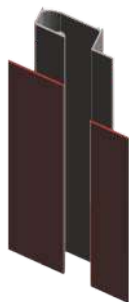

J 137 - vtopljen in poravnan ročaj s krilom vrat

Ral barva
Vidna odprtina = 45 mm
Dolžina v mm po želji kupca

PRIJEMALA



Nerjaveča pločevina mat / Les Jatoba

SG 134
L=1600 mm



Nerjaveča pločevina mat / Les hrast

SG 180
L=1200 mm



Nerjaveča pločevina mat / Les Jatoba

SG 124
L=1200 mm

s čitalcem prstnih odtisov dLine



Nerjaveča pločevina mat / Les Jatoba

SPSG 17
L=1200 mm

z mini-kamero

Led-diode, barva svetlobe bela ohišje iz nerjaveče pločevine

□ L 1 (57 x 57 mm) ○ L 2 (Ø=41 mm)

○ L 3 (Ø=60 mm) ○ L 5 (Ø=30 mm)

● L 4 (Ø=35 mm)

Zunanje rozete

Nerjaveča pločevina



RRE

Črna



RRE-S

Nerjaveča pločevina



316 238



316 239 (6)
316 240 (9)

Črna



316 741 (6)
316 742 (9)

Nerjaveča pločevina
ZAE 66R
L=X mm



Nerjaveča pločevina
310 048
L=382 mm



Nerjaveča pločevina
310 047
L=382 mm

KLJUKE



Alu - FI srebne barve
314 866



Alu - FI srebne barve
314 863

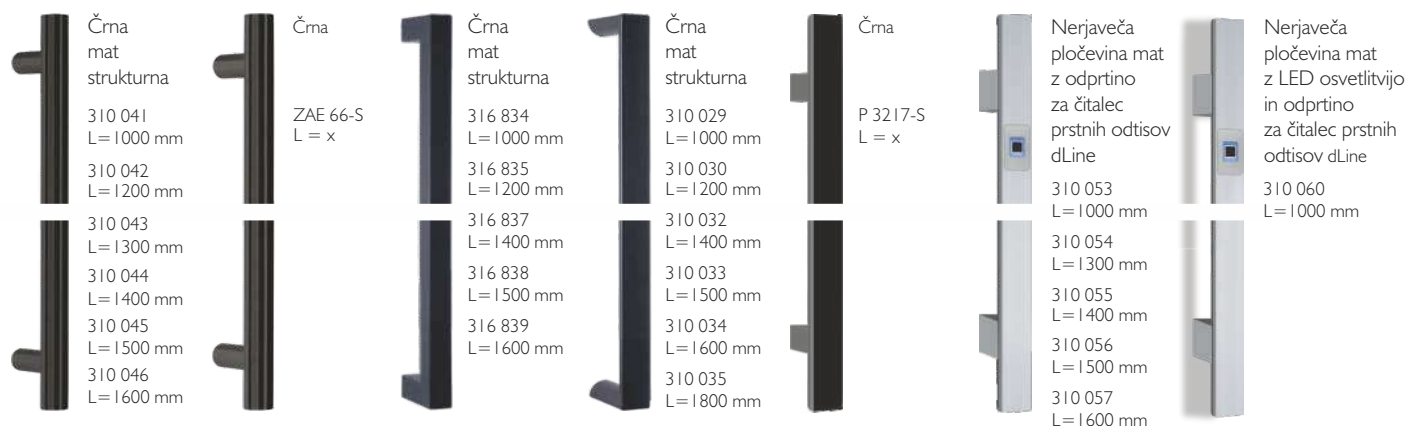
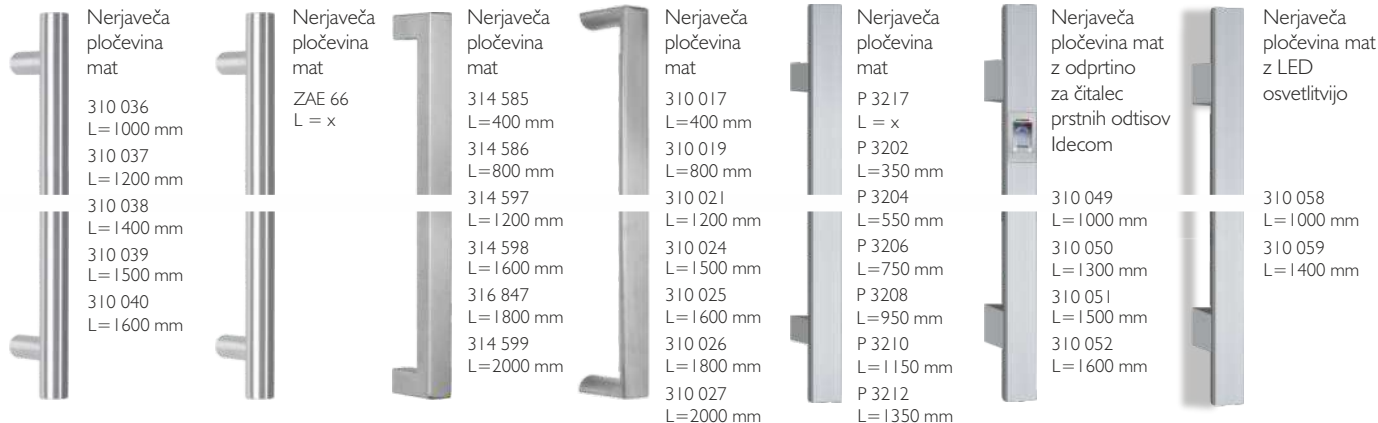

ZAŠČITA PRED PRASKAMI

Nerjaveča pločevina

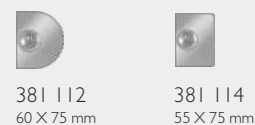

Nerjaveča pločevina 310 174 Nerjaveča pločevina 310 179 Nerjaveča pločevina 310 184 Nerjaveča pločevina 316 668 Nerjaveča pločevina 316 671 Nerjaveča pločevina 316 662 Nerjaveča pločevina 316 665

BARVE

Ponudba barv za aluminijaste površine
IZBOR

MASTER COLLECTION strukturne, metalik



Iceberg Blue
Feinstruktur Metallic



Rumbling Sky
Feinstruktur Metallic



Night Grey
Feinstruktur Metallic



Cast Iron
Feinstruktur Metallic



Russet Copper
Feinstruktur Metallic



Brown
Feinstruktur Metallic

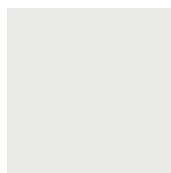

Arctic Ice
Feinstruktur Metallic



Precious Sand
Feinstruktur Metallic

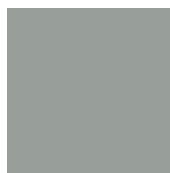

Verdigris
Feinstruktur Metallic



Granit Nature
Feinstruktur Metallic



Volcanic Ash
Feinstruktur Metallic



Elves Bench
Feinstruktur Metallic

ANODIZING COLLECTION mat, metalik

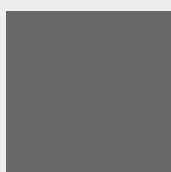

ORIGINAL PLATINIUM
Matt Metallic

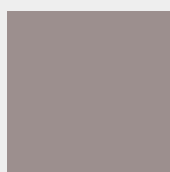

SILVER DREAM
Matt Metallic

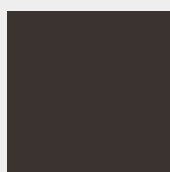

CARBON NIGHT
Matt Metallic



DARK COPPER
Matt Metallic



SIMPLY COPPER
Matt Metallic



GREY BD
Matt Metallic

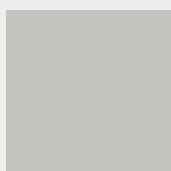

GSPED 0
Matt

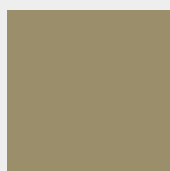

GSPED 1
Matt

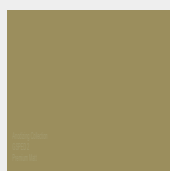

GSPED 2
Matt



GSPED 3
Matt



GSPED 4
Matt



NOBLE BRONZE
Matt Metallic

RAL barve mat, strukturne, metalik, gladke

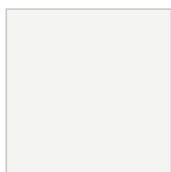

RAL 9016
Feinstruktur



RAL 7040
Feinstruktur

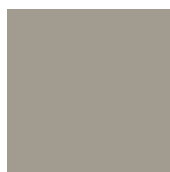

RAL 7039
Feinstruktur



RAL 7012
Feinstruktur



RAL 7015
Feinstruktur



RAL 7016
Feinstruktur

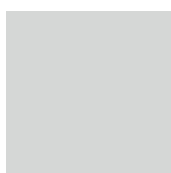

RAL 9006
Metallic glatt



RAL 9007
Metallic Feinstruktur



DB 703
Metallic Feinstruktur



RAL 7021
Feinstruktur



RAL 9005
Feinstruktur



RAL 8019
Feinstruktur

DEKOR - VIDEZ KAMNA



Dekor Concrete
Beton optik



Dekor Beton dunkel

LESNI DEKOR



Dekor Altholz
(Stadelholz-1N)

FURNIRJI - Serija TREND AT 100 New Forest



Dekor ATTERSEE



Dekor
WOLFGANGSEE



Dekor TRAUNSEE



Dekor MONDSSEE



Dekor ALTAUSSEE

LESNI DEKORJI (strukturni)

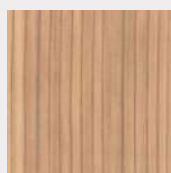

Douglas 6

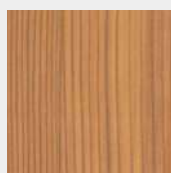

Douglas 7

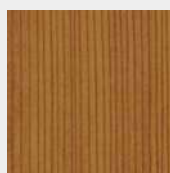

Douglas 2

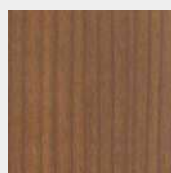

Kirsch 2

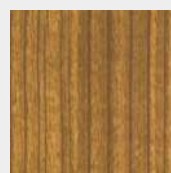

Kirsch 3

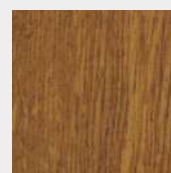

Golden Oak

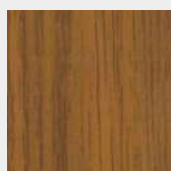

Eiche 2

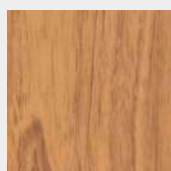

Eiche 4

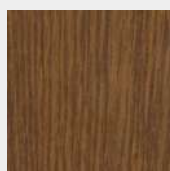

Eiche dunkel

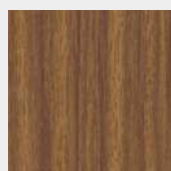

Nuss 1

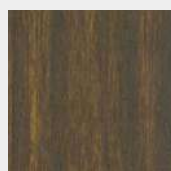

Walnuss dunkel

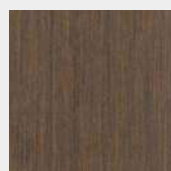

Wenge

LESNI DEKORJI - Serija REFINED

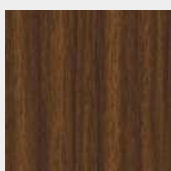

Nussbaum FS

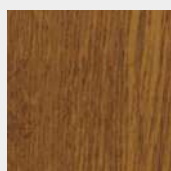

Golden Eiche FS



Helle Eiche

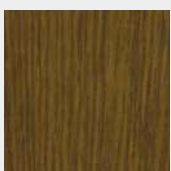

Dunkel Eiche

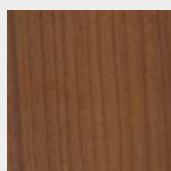

Kirsche

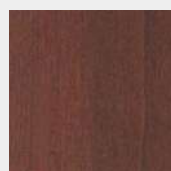

Mahagoni

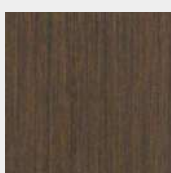

Wenge

ZASTEKLITEV

ORNAMENTNA STEKLA



Katedral Klein. belo



Chinchilla belo

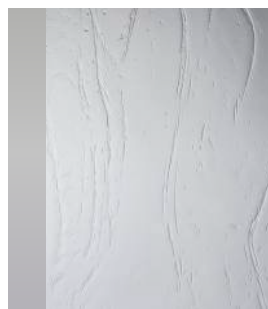

Gothic belo



Altdeutsch K belo

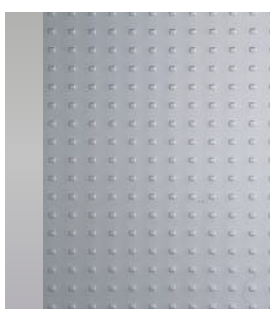

Mastercarre belo



Masterligne belo

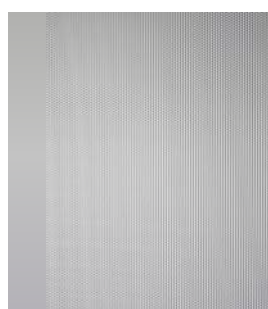

Masterpoint belo



Satinato belo

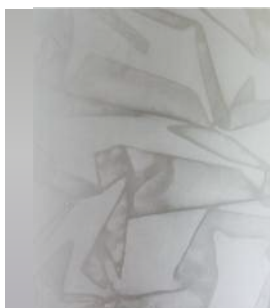

Silk belo

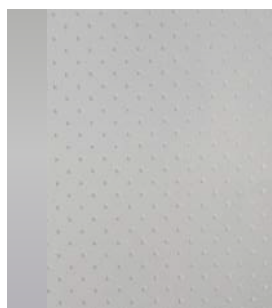

Pave belo

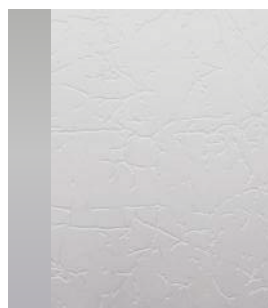

Uadi belo



Nebulosa belo

TOPLOTNO IZOLATIVNA ZASTEKLITEV

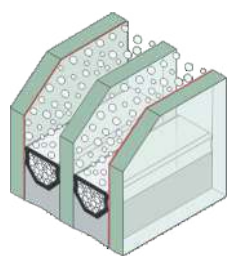

troslojno

PESKANI MOTIVI

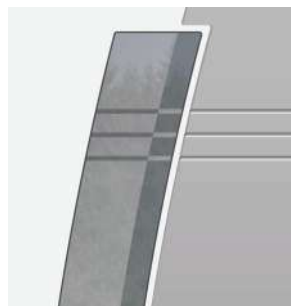

REFINED
AR



Triumph - stran 7



Canary/ AST 100A - stran 6



Levent - stran 7

TREND
New Forest
AT



AT 100 **NF** Attersee



AT 100 **NF** Wolfgangsee
- stran 8



AT 100 **NF** Mondsee
- stran 9



AT 100 **NF** Traunsee
- stran 9



AT 100/ AST 100A **NF** Altausee
- stran 9

TREND
AT



AT 100A/ AST 100A - stran 21



AT 101 - stran 21



AT 102 - stran 21



AT 100 - stran 11



AT 121 - stran 15



AT 131 - stran 12



AT 153A - stran 31



AT 255 - stran 31



AT 264 - stran 17

PREGLED MODELOV



AT 264A/AST 100A - stran 13



AT 265/AST 100A - stran 12



AT 265A - stran 17



AT 266 - stran 13



AT 266A - stran 13



AT 267 - stran 29



AT 801B - stran 18



AT 810/AST 100A - stran 15



AT 843/AST 100A - stran 29



AT 862A/AST 100A - stran 18



AT 863A/AST 100A - stran 26



AT 863B - stran 26



AT 863C - stran 27



AT 864/AST 100A - stran 28



AT 867 - stran 20



AT 875A - stran 29



AT 883/AST 100A - stran 31



AT 887 - stran 30



AT 887B - stran 30



AT 891A - stran 20



AT 894 - stran 11



AT 904 - stran 28



AT 906 - stran 19



AT 906A - stran 19



AT 907 - stran 15



AT 909/AST 100A - stran 14



AT 919 - stran 14



AT 924A/AST 100A - stran 23



AT 934 - stran 25



AT 941A/AST 100A - stran 19



AT 943 - stran 27



AT 944 - stran 22



AT 945A - stran 22



AT 946A - stran 23



AT 946B - stran 23



AT 947/AST 100A - stran 27



AT 948/AST 100A - stran 25

DELUXE
AD



AD 801A - stran 35



AD 801A/AST 100A - stran 35



AD 801B - stran 33



AD 843A - stran 33

MODERN
AM



AD 863D - stran 35



AD 945/ AST 100A - stran 34



AD 945 - stran 34



AM 132A - stran 38



AM 132A - stran 38



AM 131 - stran 39



AM 134B - stran 37



AM 156 - stran 37



AM 170 - stran 39



AM 170/ AST 100A - stran 39

CLASSIC
AC



AC 182A - stran 42



AC 183 - stran 43



AC 183 - stran 43



AC 185/ AST 185 - stran 43



AC 190A/ AST 190 - stran 45



AC 191/ AST 191 - stran 44



AC 194A - stran 44



AC 195A - stran 42



AC 203A - stran 41



AC 207- stran 41



AC 209A - stran 45



AC 209 - stran 45

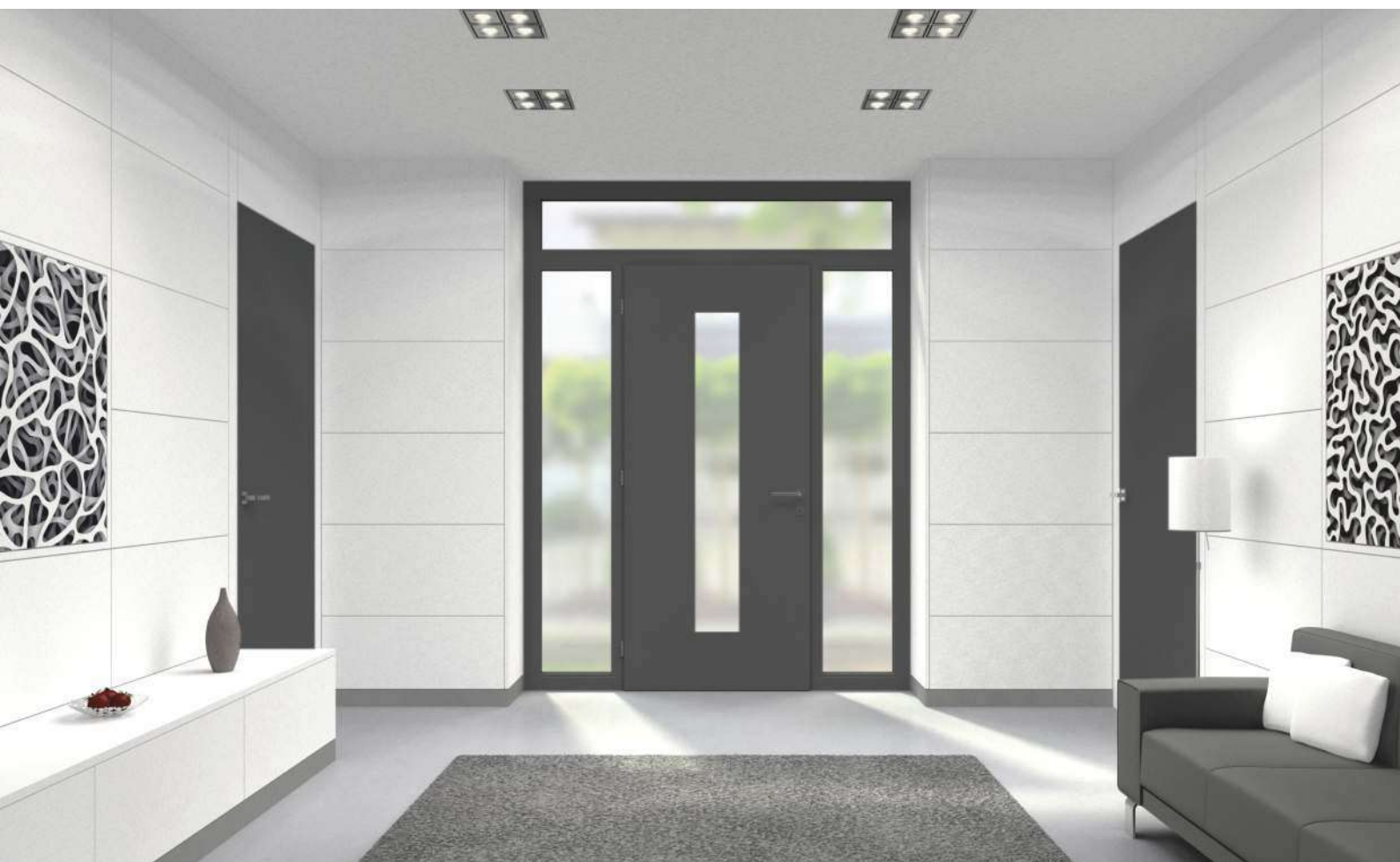

Inles

Proizvodnja, trženje in inženiring d.d.

SI - 1310 Ribnica, Kolodvorska 22
tel.: 01 8377 100, fax: 01 8377 333
e-mail: info@inles.si

RAZSTAVNO PRODAJNI SALON RIBNICA

tel.: 01 8377 111



www.inles.si

POOBLAŠČENI PRODAJALEC: