

ALUMINIJASTA VHODNA VRATA

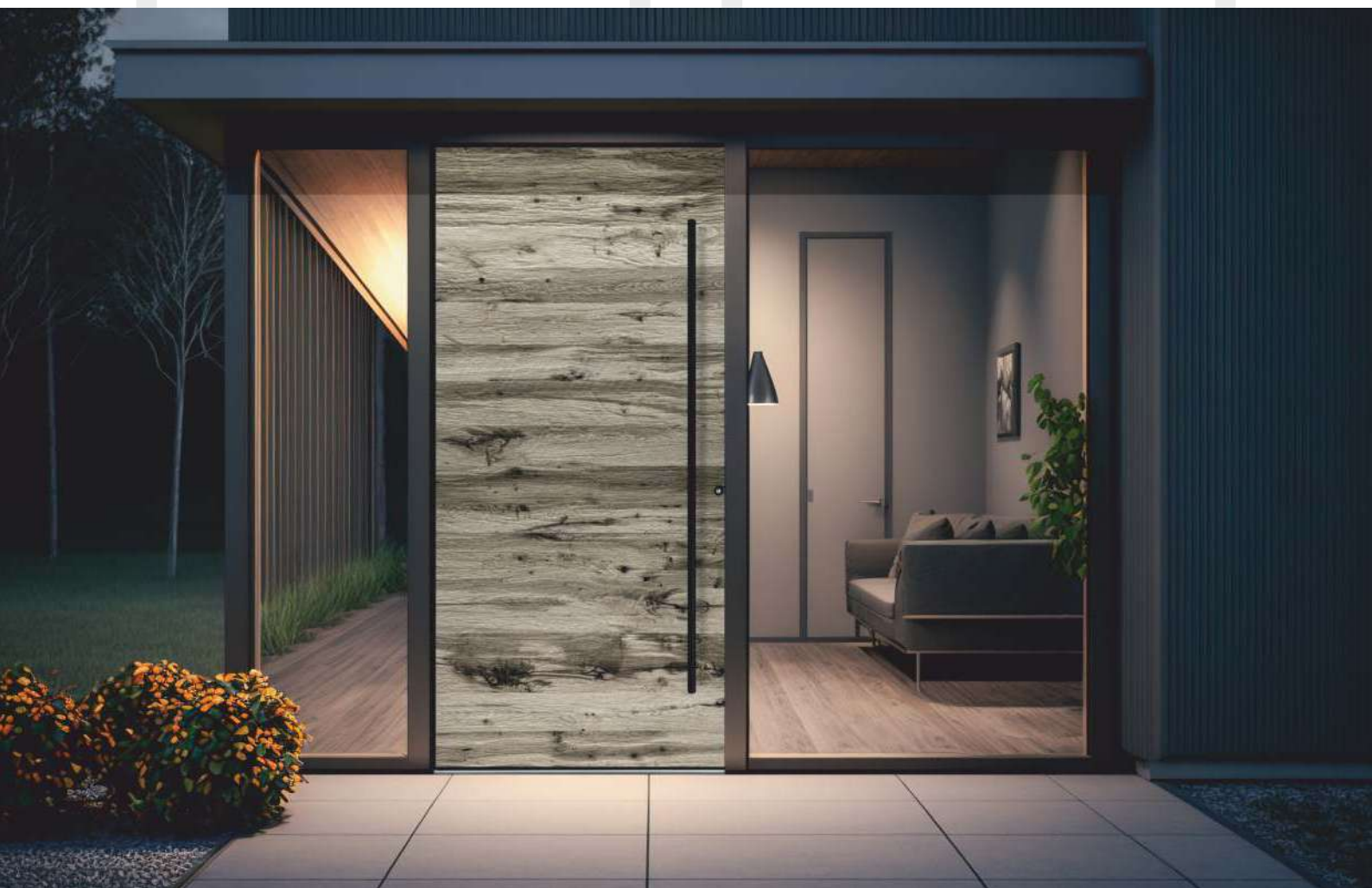

inles[®] OKNA
VRATA

TREND



Domiselni in lahkotni, drzni in razgibani so modeli vhodnih vrat iz serije TREND. Sodobno in aktualno serijo vrat zaznamuje prefinjena linija motivnih stekel, elegantne aplikacije ter vtopljeni inox trakovi, čarobna igra svetlobe vključenih led svetil in obširna kolekcija dovršenih prijemal. Prepustite se, uživajte in si izberite ter opremite svoja lastna sanjska vrata.



AT 894

Barva	DB 703 Fs Matallic + Dekor Altholz (Stadelholz- IN), prečna struktura
Utori	4/10
Steklo motiv	SG 894
Prijemalo	P 3208
Led-diode	LI

	Ud (Wm ² /K)	
EFS	1,3 (Ug 0,7)	BFS 0,89 (Ug 0,5)

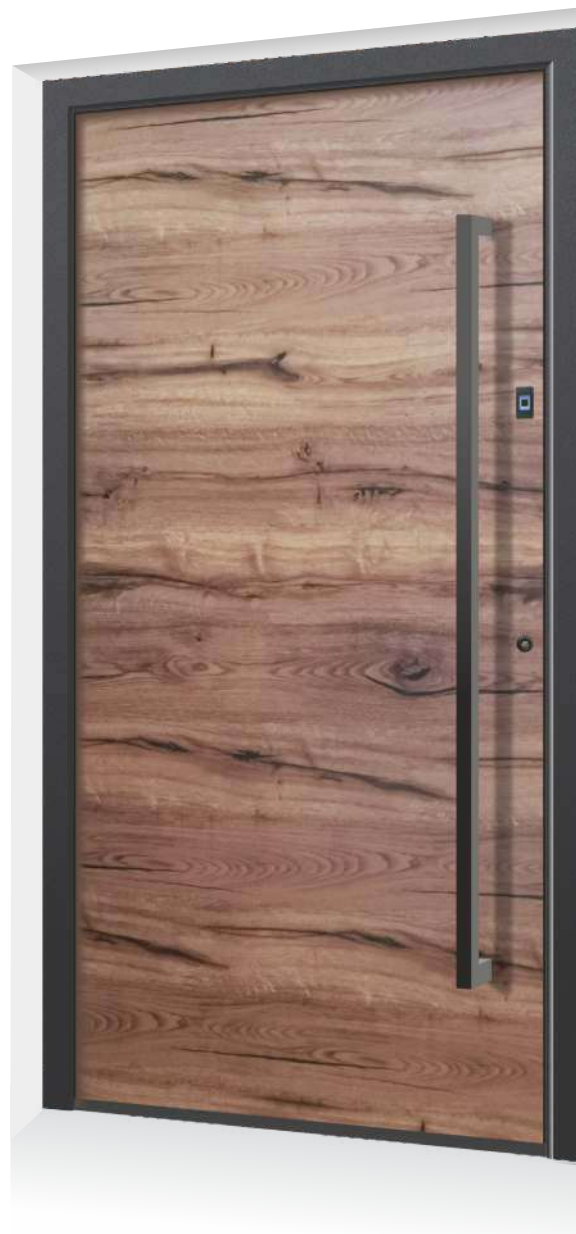

AT 100

Barva	Dekor Altholz (Stadelholz- IN), prečna struktura + Carbon Night Matt Metallic
Prijemalo	316 838
Odpiranje	na prstni odtis

	Ud (Wm ² /K)	
EFS	1,2*	BFS 0,84*



Modell AT 265/AST 100A

Barva Carbon Night Matt Metallic
Original Platinum Matt Metallic
Utori 4/10
Steklo motiv SM 265
Prijemalo SP5G 17 z mini-kamero

Ud (Wm ² /K)	
EFS 1,2*	BFS 0,84*

AT 131

Barva HD Eiche 4, prečna struktura
Ral 7005 FS
Steklo orn. Satinato belo
Prijemalo P 3217 - S

Ud (Wm ² /K)	
EFS 1,2 (Ug 0,7)	BFS 0,89 (Ug 0,5)



AT 266

Barva Night Grey Fs Metallic
 Utori 5/20
 Prijemalo 310 054 s čitalcem prstnih odtisov

Ud (Wm ² /K)	
EFS	1,2*
BFS	0,84*



AT 266A

Barva Night Grey Fs Metallic
 + Dekor Altholz
 (Stadelholz-1N), prečna struktura
 Utori 5/20
 Prijemalo 310 034

Ud (Wm ² /K)	
EFS	1,2*
BFS	0,84*



AT 264A/ AST 100A

Barva Artic Ice Fs Metallic
 Utori 2/10
 Steklo motiv SM 264A
 Prijemalo SG 134

Ud (Wm ² /K)	
EFS	1,2*
BFS	0,84*



AT 909/AST 100A

Barva	Night Grey Fs Metallic + HD Nuss I
Aplikacija	Nerjaveča pločevina 4/10
Utori	3/10
Steklo motiv	SM 909
Prijemalo	314 597

Ud (Wm ² /K)	
EFS 1,2*	BFS 0,84*

AT 919

Barva	Granit Nature Fs Metallic + HD Eiche Dunkel
Aplikacija	Nerjaveča pločevina 4/10
Steklo	Or. Satinato belo
Prijemalo	310 056 s čitalcem prstnih odtisov

Ud (Wm ² /K)	
EFS 1,3 (Ug 0,7)	BFS 0,91 (Ug 0,5)



AT 121

Barva Ral 7035 Fs
Utori 7/10
Prijemalo 310 033
Hišna številka vtopljena, črne barve

Ud (Wm ² /K)	
EFS	1,2*
BFS	0,84*



AT 907

Barva Granit Nature Fs Metallic
+ Artic Ice Fs Metallic
Aplikacija nerjaveča pločevina 6/10
Prijemalo P 3212

Ud (Wm ² /K)	
EFS	1,2*
BFS	0,84*



AT 810/AST 100A

Barva Original Platinum Matt Metallic
Utori 12/10
Steklo orn. Satinato belo
Prijemalo SG 180
Odkapna letev WSE 03

Ud (Wm ² /K)	
EFS	1,3 (Ug 0,7)
BFS	0,91 (Ug 0,5)





AT 264

Barva	Dekor Concrete Beton optik + Cast Iron Fs Metallic
Aplikacija	nerjaveča pločevina 2/10
Prijemalo	GS 113

Ud (Wm ² /K)	
EFS 1,2*	BFS 0,84*

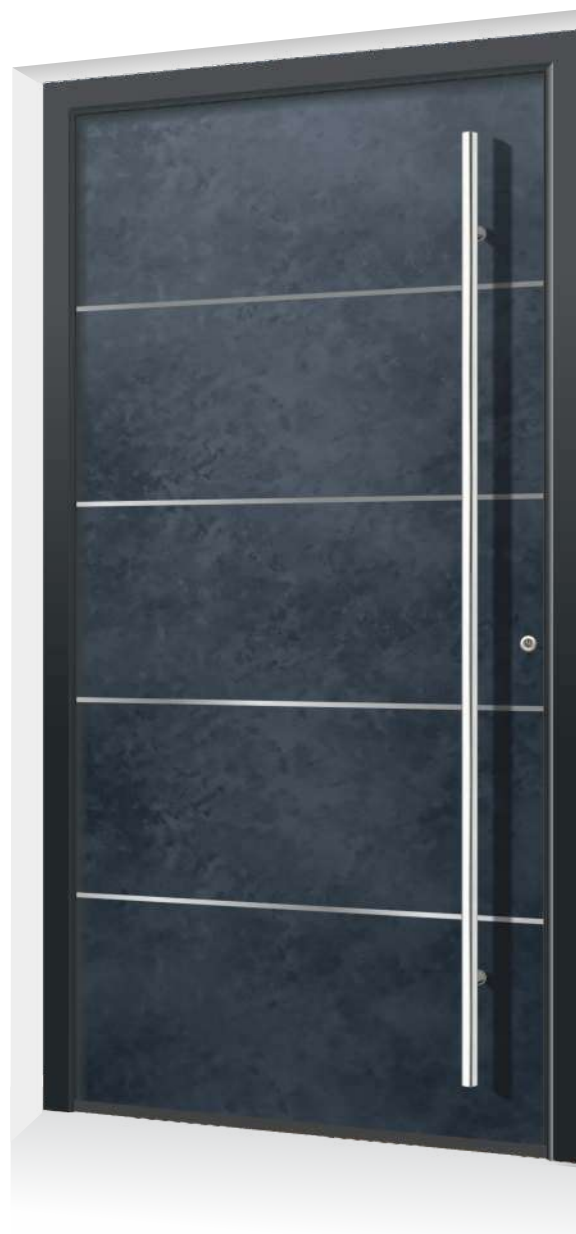

Modell AT 265A

Barva	Dekor Beton dunkel + Ral 7024
Aplikacija	nerjaveča pločevina 4/10
Prijemalo	ZAE 66

Ud (Wm ² /K)	
EFS 1,2*	BFS 0,84*



AT 862A/AST 100A

Barva 6768 Braun Fs
 Aplikacija Nerjaveča pločevina 6/10
 Steklo motiv SG 862A, SM 862A
 Prijemalo 310 059 mit LED

Ud (Wm²/K)
 EFS | 1,3 (Ug 0,7) | BFS | 0,92 (Ug 0,5)



AT 801B

Barva Dekor Concrete Beton optik
 + Ral 9005 Fs
 Aplikacija Aluminium 2/10, Ral 9005 Fs
 Steklo orn. Satinato belo
 Prijemalo 316 839

Ud (Wm²/K)
 EFS | 1,3 (Ug 0,7) | BFS | 0,91 (Ug 0,5)



AT 906A

Barva Granit Nature Fs Metallic
 Aplikacija nerjaveča pločevina 1/20, 5/10
 Steklo orn. Satinato belo
 Prijemalo P 3214

Ud (Wm²/K)

EFS	1,3 (Ug 0,7)	BFS	0,92 (Ug 0,5)
-----	--------------	-----	---------------



AT 906

Barva Granit Nature Fs Metallic
 + HD Douglas 7
 Aplikacija nerjaveča pločevina 5/10, 1/20
 Steklomotiv SG 906
 Prijemalo 314 597

Ud (Wm²/K)

EFS	1,3 (Ug 0,7)	BFS	0,92 (Ug 0,5)
-----	--------------	-----	---------------



AT 941A/AST 100A

Barva Night Grey Fs Metallic
 Aplikacija nerjaveča pločevina 6/10
 Steklo orn. Satinato belo
 Prijemalo SG 124 s čitalcem prstnih odtisov

Ud (Wm²/K)

EFS	1,3 (Ug 0,7)	BFS	0,92 (Ug 0,5)
-----	--------------	-----	---------------



AT 891A

Barva HD Eiche 2
 Utori 6/20
 Steklo motiv SG 891A
 Prijemalo 310 024

Ud (Wm ² /K)	
EFS 1,2 (Ug 0,7)	BFS 0,97 (Ug 0,5)

AT 867

Barva Ral 9016 Fs
 Steklo motiv SG 867
 Prijemalo 310 021

Ud (Wm ² /K)	
EFS 1,2 (Ug 0,7)	BFS 0,99 (Ug 0,5)



AT 102

Barva Russet Copper Fs Metallic
Steklo klar
Prijemalo 3 16 866 poševna pritrditev

Ud (Wm ² /K)	
RT	1,4 (Ug 0,7) 1,3 (Ug 0,5)



AT 100A/AST 100A

Barva Ral 9016 Fs
Steklo orn. Satinato belo
Prijemalo ZAE 66 - S

Ud (Wm ² /K)	
RT	1,2 (Ug 0,7) 1,1 (Ug 0,5)



AT 101

Barva Ral 7016 Fs
Steklo prozorno
Prijemalo P 3217
Odpiranje na prstni odtis

Ud (Wm ² /K)	
RT	1,3 (Ug 0,7) 1,2 (Ug 0,5)



AT 944

Barva HD Douglas 6
 Steklo orn. Satinato belo
 Prijemalo P 3214
 Odkapna letev WSE 03

Ud (Wm²/K)
 EFS | 1,3 (Ug 0,7) | BFS | 0,91 (Ug 0,5)



AT 945A

Barva GSPED 0 Matt
 + HD Nuss I
 Steklo orn. Satinato belo
 Prijemalo P 3217- S
 Odpiranje na prstni odtis

Ud (Wm²/K)
 EFS | 1,3 (Ug 0,7) | BFS | 0,93 (Ug 0,5)



AT 946B

Barva Precious Sand Fs Metallic
 Utori 14/20
 Steklo motiv SG 946A
 Prijemalo 310 024

Ud (Wm²/K)

EFS | **1,3** (Ug 0,7) | BFS | **0,92** (Ug 0,5)



AT 946A

Barva Night Grey Fs Metallic
 Steklo motiv SG 946A
 Prijemalo J-137 - Gold Supreme
 Fs Metallic - vtopljen in poravn s krilom

Ud (Wm²/K)

EFS | **1,3** (Ug 0,7) | BFS | **0,92** (Ug 0,5)



AT 924A/ AST 100A

Barva Rumbling Sky Fs Metallic
 Utori 8/10
 Steklo motiv SG 924A, SM 924A
 Prijemalo 310 037

Ud (Wm²/K)

EFS | **1,3** (Ug 0,7) | BFS | **0,93** (Ug 0,5)





AT 948/AST 100A

Barva	Artic Ice Fs Metallic
Utori	2/10
Steklo motiv	peskano, SM 948
Prijemalo	ZAE 66 - S

	Ud (Wm ² /K)	
EFS	1,3 (Ug 0,7)	BFS 0,97 (Ug 0,5)



AT 934

Barva	Cast Iron Fs Metallic
Aplikacija	Nerjaveča pločevina 4/10
Steklo	orn. Satinato belo
Prijemalo	P 3212
Odkapna letev	WSE 03

	Ud (Wm ² /K)	
EFS	1,3 (Ug 0,7)	BFS 0,92 (Ug 0,5)



AT 863A/ AST 100A

Barva Rostiges Eisen Fs
 Aplikacija Nerjaveča pločevina 4/10
 Steklo motiv peskano, SM 863A
 Prijemalo P 3214

Ud (Wm²/K)
 EFS | 1,3 (Ug 0,7) | BFS | 0,92 (Ug 0,5)



AT 863B

Barva DB 703 Metallic glatt
 Utori 5/10
 Steklo orn. Satinato belo
 Prijemalo SG 124 s čitalcem prstnih odtisov
 Odkapna letev WSE 03

Ud (Wm²/K)
 EFS | 1,3 (Ug 0,7) | BFS | 0,92 (Ug 0,5)



AT 943

Barva Original Platinum Matt Metallic
 Aplikacija nerjaveča pločevina 9/10
 Steklo orn. Satinato belo
 Prijemalo P 3217

Ud (Wm²/K)
 EFS | **1,3** (Ug 0,7) | BFS | **0,93** (Ug 0,5)



AT 947/AST 100A

Barva Cast Iron Fs Metallic
 Steklo motiv peskano, SM 947
 Prijemalo 310 039

Ud (Wm²/K)
 EFS | **1,3** (Ug 0,7) | BFS | **0,94** (Ug 0,5)



AT 863C

Barva Brown Fs Metallic
 Aplikacija Nerjaveča pločevina 7/10
 Steklo orn. Satinato belo
 Prijemalo P 3217

Ud (Wm²/K)
 EFS | **1,3** (Ug 0,7) | BFS | **0,91** (Ug 0,5)



AT 864/AST 100A

Barva GSPED 3 Matt
 Utori 6/10
 Steklo motiv peskano, SM 864
 Prijemalo 314 585

Ud (Wm²/K)
 EFS | 1,4 (Ug 0,7) | BFS | 1,0 (Ug 0,5)



AT 904

Barva Volcanish Ash Fs Metallic
 Aplikacija Nerjaveča pločevina 4/20, 1/60
 Steklo orn. Satinato belo
 Prijemalo 316 860

Ud (Wm²/K)
 EFS | 1,3 (Ug 0,7) | BFS | 0,92 (Ug 0,5)



AT 267

Barva DB 703 Metallic glatt
 Aplikacija nerjaveča pločevina 10/20
 Steklo možno samo Orn. Satinato belo obojstransko
 Prijemalo 314 585

Ud (Wm ² /K)	
EFS	1,2 (Ug 0,7) BFS
	0,84 (Ug 0,5)



AT 843/AST 100A

Barva Ral 7016 Fs
 Aplikacija Nerjaveča pločevina 2/50
 Steklo orn. Satinato belo
 Prijemalo 314 598

Ud (Wm ² /K)	
EFS	1,3 (Ug 0,7) BFS
	0,89 (Ug 0,5)



AT 875A

Barva Noble Bronze Matt Metallic
 Aplikacija Nerjaveča pločevina 2/10
 Steklo orn. Satinato belo
 Prijemalo 310 024

Ud (Wm ² /K)	
EFS	1,3 (Ug 0,7) BFS
	0,97 (Ug 0,5)



AT 887

Barva Original Platinum Matt Metallic
+ HD Eiche dunkel
Applikacija Nerjaveča pločevina 4/10
Steklo orn. Satinato belo
Prijemalo ZAE 66R
Odpiranje na prstni odtis

Ud (Wm²/K)
EFS | 1,3 (Ug 0,7) | BFS | 0,92 (Ug 0,5)



AT 887B

Barva GSPED 0 Matt
Utori 4/10
Steklotiv SG 887B
Prijemalo SG 124 s čitalcem prstnih odtisov

Ud (Wm²/K)
EFS | 1,3 (Ug 0,7) | BFS | 0,92 (Ug 0,5)



AT 153A

Barva Cast Iron Fs Metallic
 Steklo orn. Satinato belo
 Prijemalo ZAE 66R
 Odpiranje na prstni odtis

Ud (Wm²/K)

EFS | 1,4 (Ug 0,7) | BFS | 1,0 (Ug 0,5)



AT 255

Barva Precious Sand Fs Metallic
 + HD Eiche Dunkel,
 prečna struktura
 Utori 5/10
 Steklo orn. Satinato belo
 Prijemalo ZAE 66

Ud (Wm²/K)

EFS | 1,4 (Ug 0,7) | BFS | 1,0 (Ug 0,5)



AT 883/AST 100A

Barva Rumbling Sky Fs Metallic
 + Artic Ice Fs Metallic
 Aplikacija Nerjaveča pločevina 3/10 + 1 Form
 Steklo motiv peskano, SM 883
 Prijemalo TG 80

Ud (Wm²/K)

EFS | 1,3 (Ug 0,7) | BFS | 0,92 (Ug 0,5)

SISTEM ADS.SI

- ☐ Profil okvirja iz aluminija debeline 75 ali 95 mm ravnih ali zaobljenih linij. Profil krila iz aluminija je debeline 85 in 75mm.
- ☐ Na sredini profilov za okvir in krilo je termo člen, ki izboljša toplotne karakteristike profila.
- ☐ Polnila iz trde PUR pene oblečene v aluminij z dobrimi toplotno izolativnimi karakteristikami.
- ☐ Pri izvedbah z obojestransko prekritim krilom brez stekelnega izreza ter dimenziji vrat 1100 x 2100 mm, se dosega toplotna prehodnost vrat $U_d = 0,84 \text{ W/m}^2\text{K}$, pri enostransko prekritih alu vhodnih vratih se dosega vrednost $U_d 1,2 \text{ W/m}^2\text{K}$.



OKOVJE

- ☐ Kakovostna in praktična nasadila.
- ☐ 5-kratna zapora krila standardno.
- ☐ Razne opcije odpiranja- odpiranje navzven, odpiranje na prstni odtis, električno odpiranje, ...

ZASTEKLITEV

- ☐ Na izbiro imamo široko paleto toplotno in zvočno izolativnih ter varnostnih stekel.
- ☐ Velika izbira ornamentev in vitražev tudi po vaših željah.
- ☐ Dodelava stekla z različnimi folijami, steklenimi dodatki, peskanjem, ...



POVRŠINSKA OBDELAVA

- ☐ Prašno lakiranje površin je ekološko prijaznejše in zagotavlja odlično kakovost ter obstojnost obarvane površine.
- ☐ Široka paleta aktualnih standardnih barv.
- ☐ Širok izbor strukturnih ali gladkih barvnih površin aluminija, barve po Ral barvni karti ter imitacije lesnih dekorjev.

ODPIRANJE

Opiranje navznoter, pogled od **zunaj**



DIN LEVO



DIN DESNO

PREGLED TIPOV

odpiranje navznoter, pogled od **znotraj**

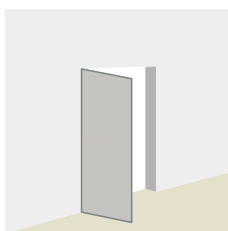

Tip 01

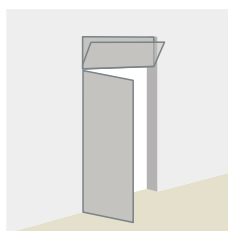

Tip 02/03

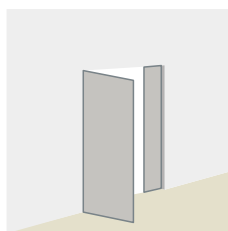

Tip 04

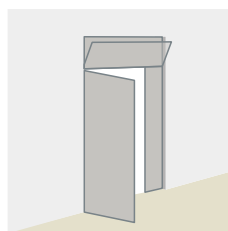

Tip 05/06

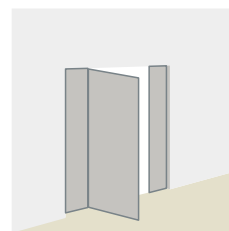

Tip 07

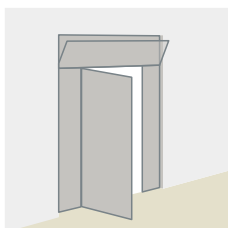

Tip 08/09

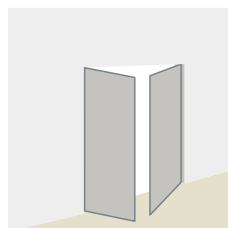

Tip 21

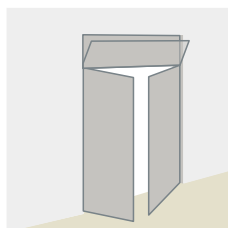

Tip 22/23

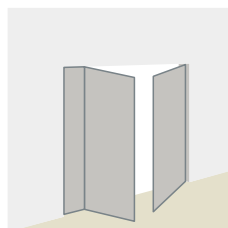

Tip 24

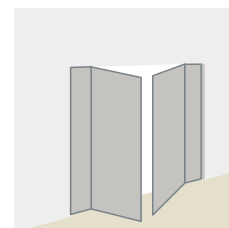

Tip 25

Aluminijasta vhodna vrata **zunanja stran**

Model AT 100, sistem ADS 75B.SI

poravnana

Barva: krilo Dekor Altholz (Stadelholz-IN), prečna struktura

Okvir: Cast Iron Fs Metallic



Les/ aluminij okno **zunanja stran**

INO-HA80-MM poravnana

INO-HA80-F poravnana

Barva Alu: Cast Iron Fs Metallic

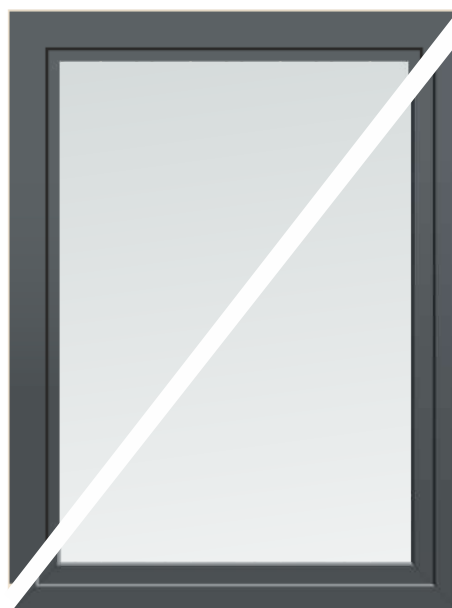

PVC/ aluminij okno **zunanja stran**

Living Top Alu - standardna izvedba

Barva Alu: Cast Iron Fs Metallic

BEDIENUNGSKOMFORT



Odpiranje na prstni odtis
s čitalcem DLine



Odpiranje na prstni odtis
s čitalcem Idencom



Prijemalo SG 124
s čitalcem dLine



Smart unlock
tipkovnica

Aluminijasta vhodna vrata **notranja stran**

Model AT 100, Sistem ADS 75B.SI

poravnana

Barva: krilo in okvir: Cast Iron Fs Metallic

Les/ aluminij okno **notranja stran**

INO-HA80-MM *poravnana*

INO-HA80-F - standardna izvedba

Barva Holz: DB 703



PVC/ aluminij okno **notranja stran**

Living Top Alu - standardna izvedba

Barva PVC: Mattex Shine dark graphite



LED OSVETLITEV



Prijemalo z Led-osvetlitvijo,
z zaščito pred praskami
in aplikacijo iz nerjaveče pločevine



LED-Diode

DIGITALNO KUKALO



LCD

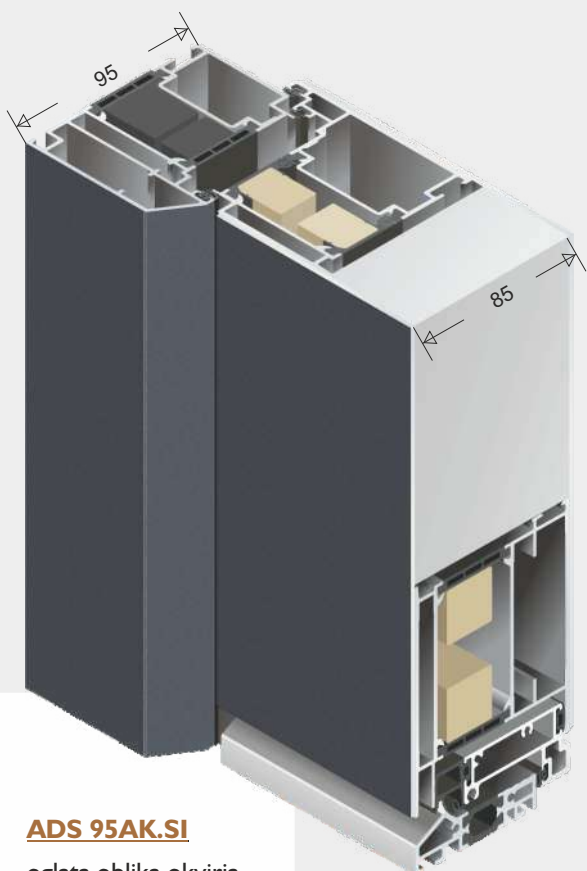

ADS 95AK.SI

oglata oblika okvirja

obojestransko prekrivno krilo

$U_d = 0,81 \text{ W/m}^2\text{K}$

(U_d vrednost velja za velikost vrat 1230 x 2180 mm, brez izreza za steklo)

$U_d = 0,84 \text{ W/m}^2\text{K}$

(U_d vrednost velja za velikost vrat 1230 x 2180 mm, brez izreza za steklo)



ADS 95.SI

okrogla oblika okvirja

troslojna
zasteklitev

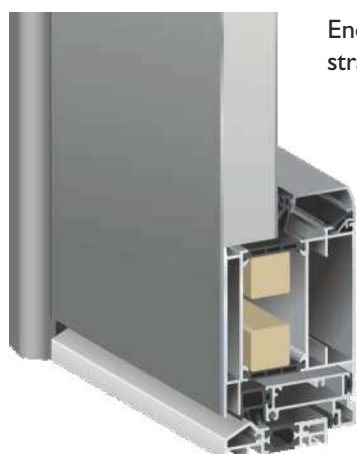

Enostransko - na zunanji strani prekrivno krilo

$U_d = 1,2 \text{ W/m}^2\text{K}$

(brez izreza za steklo)



Izvedba z vidnim okvirjem na krilu

Pri teh modelih so okvirji kril vidni, tako znotraj kot zunaj.

Na voljo so v vseh različicah vhodnih vrat, razen v seriji Refined, New Forest in Deluxe.



ADS 75B.SI

poravnan okvir s krilom
na zunanji in notranji strani



Ud = 0,83 W/m²K

(Ud vrednost velja za velikost vrat 1230 x 2180 mm, brez izreza za steklo)

Ud = 0,87 W/m²K

(Ud vrednost velja za velikost vrat 1230 x 2180 mm, brez izreza za steklo)

obojestransko prekrivno krilo

Ud = 0,81 W/m²K

(Ud vrednost velja za velikost vrat 1230 x 2180 mm, brez izreza za steklo)

Ud = 0,84 W/m²K

(Ud vrednost velja za velikost vrat 1230 x 2180 mm, brez izreza za steklo)



ADS 75.SI

poravnan okvir s krilom
samo na zunanji strani

IZVEDBE ZASTEKLITVENIH LETVIC

OVR

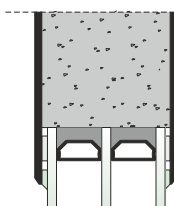

Serija **TREND**

EVR enostransko

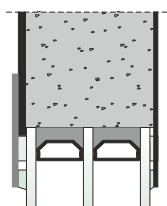

Serija **DELUXE**
(standardno)

EVR obojestransko

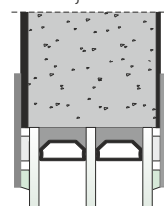

Serija **DELUXE**

AVR

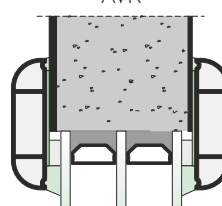

Seriji **MODERN, CLASSIC**

SVR

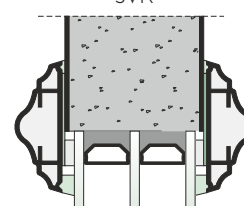



RC2 – visoka stopnja varnosti

Varnost nepremičnine je bila in ostaja pomemben dejavnik pri izbiri aluminijastih vhodnih vrat.

Aluminijasta vrata poleg visokega kakovostnega standarda že serijsko vključujejo **5-točkovno zaklepanje (zapahi in vrtljivi zatiči)**, kar zagotavlja dodatno zaščito.

Na voljo so tudi **v certificiranih varnostnih razredih RC I in RC2**.

Za še večjo prilagodljivost lahko izbirate med dodatnimi, naprednimi rešitvami zaklepanja ter individualno opremo, ki povečuje udobje uporabe.



RC2 AUSFÜHRUNG

1 VARNOSTNI ZATIČI



2 VARNOSTNO STEKLO P4A



3 OMEJEVALEC DVIGA KRILA



4 VARNOSTNI CILINDER Z ZAŠČITO PROTI PREVRTANJU

5 VARNOSTNA GARNITURA



3 TRODIMENZIONALNA NASADILA



4 POHODNI PRAG

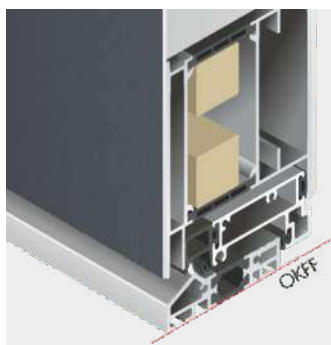

FPI (standard)

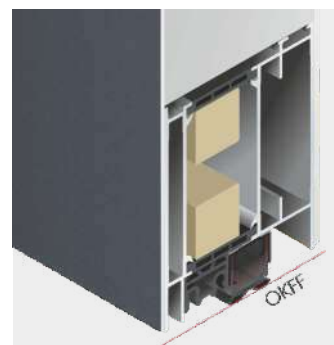

FP5 avtomatsko tesnilo



ATVE 5
5-kratna ZAPORA
 - iz nerjaveče pločevine,
 z varnostnimi zatiči
 in kavliji

osnovna varnost
 serijsko

Mehanski večtokovni sistem zaklepanja, pri katerem osnovno ključavnico in dodatne zapirne elemente (kavelj in varnostni zatič) poslužujemo s pomočjo ključa cilindra



ATVK 5
5-kratna ZAPORA s komfort funkcijo
 - iz nerjaveče pločevine,
 z varnostnimi zatiči
 in kavliji

Mehanski večtokovni sistem zaklepanja (kavelj, varnostni zatič)
 - Z notranje strani je vedno omogočeno odpiranje s kljuko, tudi v primeru zaklenjenih vrat (komfortna funkcija)

- Obvezen prostovrteči cilindar

- Možna samo izvedba kljuka/ bunka ali držalo/ kljuka

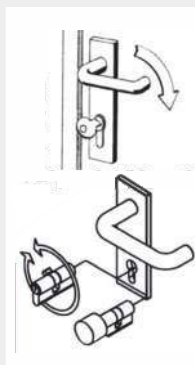

ATVS 5
5-kratna ZAPORA
 - iz nerjaveče pločevine
 Z varnostnimi zatiči, kavliji
 ter varnostnim vratnim lovilcem

Sistem večtokovnega zaklepanja (kavelj, varnostni zatič) in varnostnega vratnega lovilca, ki dopušča le režno odpiranje vrat za nekaj cm, tako da ne more vstopiti nepovabljen gost

Od znotraj se vratni lovilce upravlja z vrtljivim gumbom, od zunaj pa s ključem preko glavne ključavnice.



ELEKTRO-ODPIRALO



SKRITA NASADILA



Za vrata z odpiranjem navznoter
 - 100° kot odpiranja



Za vrata z odpiranjem navzven
 ter za sistem ADS 75B.SI
 - 180° kot odpiranja



ATVE A
5-kratno varnostno zaklepanje vrat AVTOMATSKO, MEHANSKO

Avtomatsko večtočkovno zaklepanje z integrirano samonastavitvijo.

- 1 Vedno zanesljivo varno. Da so vrata vedno zanesljivo zaklenjena, je vgrajen avtomatski sprožilni zapah.
- 2 Dnevno odklepanje: odhod iz hiše brez ključa. Praktično za vse vsakodnevne situacije, ko želimo objekt za kratek čas zapustiti brez ključa: preprosto izklopite avtomatsko funkcijo s pomočjo drsnika za dnevno odklepanje in sprostite zapah glavne ključavnice na okvirju.

ATVE A-M
5-kratno varnostno zaklepanje vrat AVTOMATSKO, z motorno funkcijo vklj. napajanje

- Zaklepne elemente je mogoče mehansko zakleniti.

- Odklepanje preko domofona, biometrije ... (zapah glavne ključavnice ne sme biti predhodno zaklenjen)



ATVS 5EA
5-kratna zapora Genius

Nerjaveča pločevina, vključno z napajalnikom, z elektromehanskim pogonom, profilni cilindri s prostim tekom z zaščito proti vrtnanju in varnostno funkcijo, vključno 6 ključi. Pozor: uporabljajte izključno cilindre z oznako FZG!

Ko so vrata zaprta, se v nočnem načinu samodejno zaklenejo z motorjem (pribl. 3 sek.). Vsi obstoječi zaklepni elementi se iztegnejo. Vrata je mogoče odkleniti ročno s cilindričnim ključem ali samodejno preko zunanjega sistema kontrole dostopa.

Ko so vrata popolnoma zaklenjena, je prav tako mogoče od znotraj s kljuko umakniti vse zaporne elemente in tako vrata hitro odpreti.

CILINDRIČNI VLOŽKI



Cilindrični vložek z dvostranskim varnostnim delovanjem in 6 ključi (standardno)



Cilindrični vložek z zaščito proti prevrtanju in 6 ključi



Prosto vrteč cilindrični vložek z zaščito proti prevrtanju, z dvostranskim varnostnim delovanjem in 6 ključi

SISTEM KONTROLE DOSTOPA (ATVE A-M, ATVS 5EA GENIUS)



dLine



dLine črne barve



Smart unilock

Smart unilock je inovativna tipkovnica, ki združuje odpiranje preko mobilne aplikacije, prstnega odtisa, kode ali RFID v enem izdelku.



Idencom

Aluminjasta vhodna vrata **zunanja stran**

Model AT 894, Sistem ADS 95AK.SI

Barva: Cast Iron Fs Metallic, HD Walnuss dunkel

Hišna številka - nerjaveča pločevina

HIŠNA ŠTEVILKA
- MOTIV NA STEKLU



KUKALO



Medenina polirana / satinirana krom

ZUNANJA OKROGLA ROZETA



Nerjaveča pločevina (standard) črna

ODKAPNA LETEV



Različni sistemi pisemskih nabiralnikov



WSE 03, Nerjaveča pločevina kot aplikacija



WSE 01, Nerjaveča pločevina



WSE 02, Nerjaveča pločevina

Aluminijasta vhodna vrata **notranja stran**

Model AT 894, Sistem ADS 95AK.SI

Barva: Ral 9016 FS

Vratno zapiralo TS 5000



NOTRANJA PRIJEMALA IN ROZETE



Notranje kljuke I200

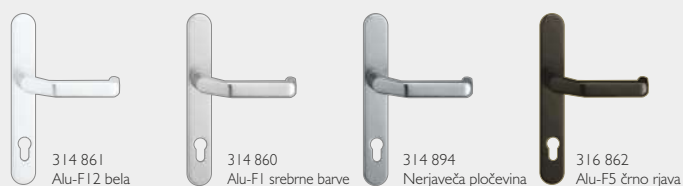

Nasadila

VTOPLJENA PRIJEMALA

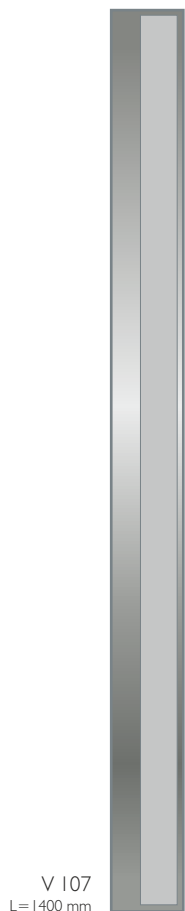

GS-113



GS-88

STOßGRIFFE



SG-49

VTOPLJENO PRIJEMALO



J 137 - vtopljen in poravnan ročaj s krilom vrat

Ral barva
Vidna odprtina = 45 mm
Dolžina v mm po želji kupca

PRIJEMALA



Nerjaveča pločevina mat / Les Jatoba

SG 134
L=1600 mm



Nerjaveča pločevina mat / Les hrast

SG 180
L=1200 mm



Nerjaveča pločevina mat / Les Jatoba

SG 124
L=1200 mm

s čitalcem prstnih odtisov dLine



Nerjaveča pločevina mat / Les Jatoba

SPSG 17
L=1200 mm

z mini-kamero

Led-diode, barva svetlobe bela ohišje iz nerjaveče pločevine

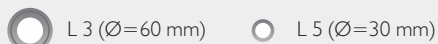
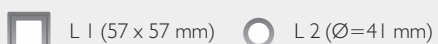

Zunanje rozete



Nerjaveča pločevina
ZAE 66R
L=X mm



Nerjaveča pločevina
310 048
L=382 mm



Nerjaveča pločevina
310 047
L=382 mm

KLJUKE



Alu - FI srebne barve
314 866



Alu - FI srebne barve
314 863

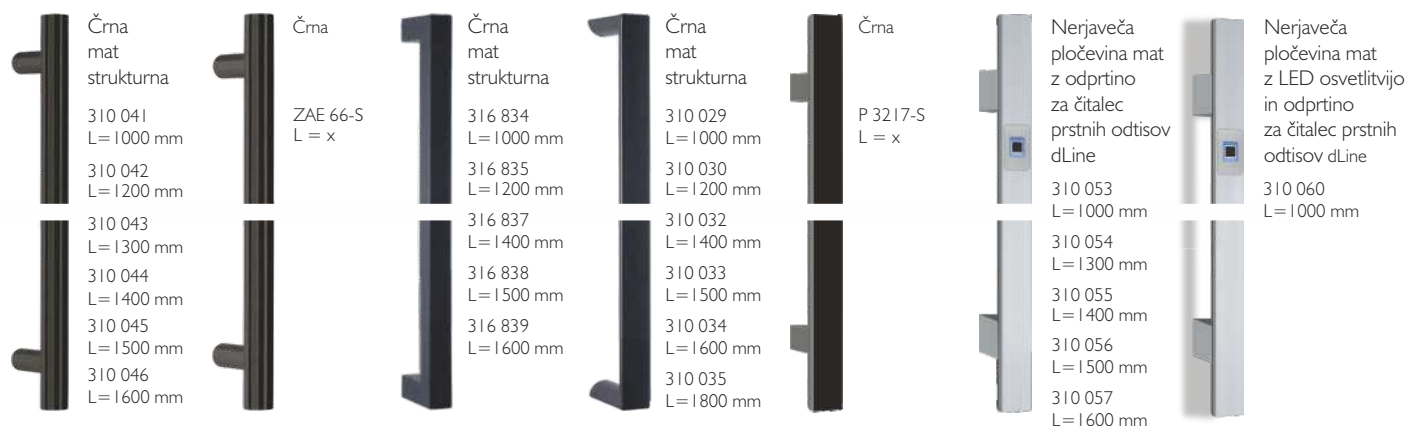
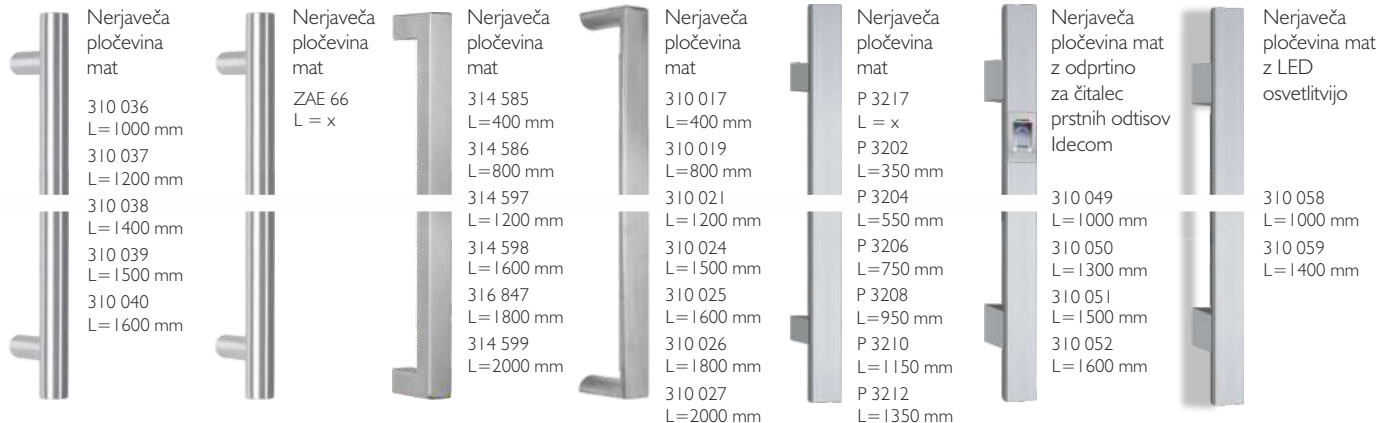

ZAŠČITA PRED PRASKAMI

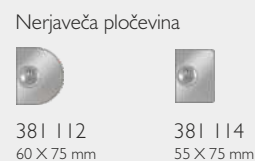

Nerjaveča pločevina 310 174 Nerjaveča pločevina 310 179 Nerjaveča pločevina 310 184 Nerjaveča pločevina 316 668 Nerjaveča pločevina 316 671 Nerjaveča pločevina 316 662 Nerjaveča pločevina 316 665

Ponudba barv za aluminijaste površine
IZBOR

MASTER COLLECTION strukturne, metalik



Iceberg Blue
Feinstruktur Metallic



Rumbling Sky
Feinstruktur Metallic



Night Grey
Feinstruktur Metallic



Cast Iron
Feinstruktur Metallic



Russet Copper
Feinstruktur Metallic



Brown
Feinstruktur Metallic

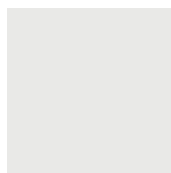

Artic Ice
Feinstruktur Metallic



Precious Sand
Feinstruktur Metallic

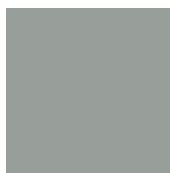

Verdigris
Feinstruktur Metallic



Granit Nature
Feinstruktur Metallic



Volcanic Ash
Feinstruktur Metallic



Elves Bench
Feinstruktur Metallic

ANODIZING COLLECTION mat, metalik

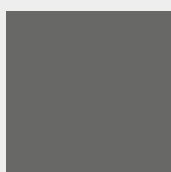

ORIGINAL PLATINIUM
Matt Metallic

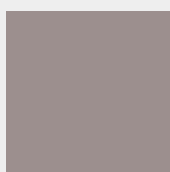

SILVER DREAM
Matt Metallic

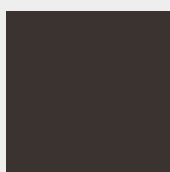

CARBON NIGHT
Matt Metallic

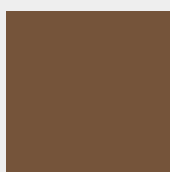

DARK COPPER
Matt Metallic



SIMPLY COPPER
Matt Metallic



GREY BD
Matt Metallic

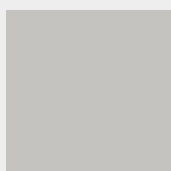

GSPED 0
Matt

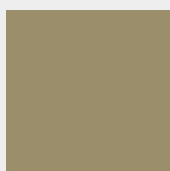

GSPED 1
Matt

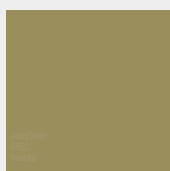

GSPED 2
Matt



GSPED 3
Matt

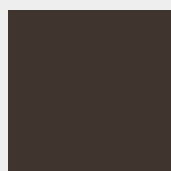

GSPED 4
Matt



NOBLE BRONZE
Matt Metallic

RAL barve mat, strukturne, metalik, gladke

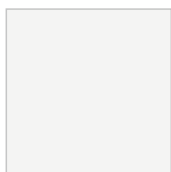

RAL 9016
Feinstruktur



RAL 7040
Feinstruktur

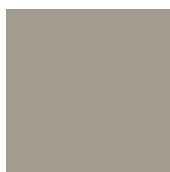

RAL 7039
Feinstruktur



RAL 7012
Feinstruktur



RAL 7015
Feinstruktur



RAL 7016
Feinstruktur

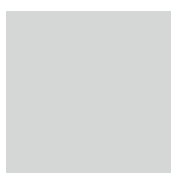

RAL 9006
Metallic glatt



RAL 9007
Metallic Feinstruktur



DB 703
Metallic Feinstruktur



RAL 7021
Feinstruktur



RAL 9005
Feinstruktur



RAL 8019
Feinstruktur

DEKOR - VIDEZ KAMNA



Dekor Concrete
Beton optik



Dekor Beton dunkel

LESNI DEKOR



Dekor Altholz
(Stadelholz-1N)

FURNIRJI - Serija TREND AT 100 **New Forest**



Dekor ATTERSEE



Dekor
WOLFGANGSEE



Dekor TRAUNSEE



Dekor MONDSSEE



Dekor ALTAUSSEE

LESNI DEKORJI (strukturni)

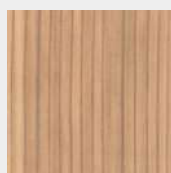

Douglas 6

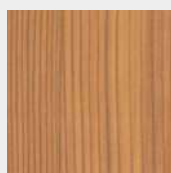

Douglas 7

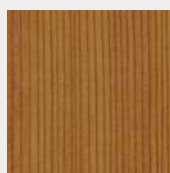

Douglas 2

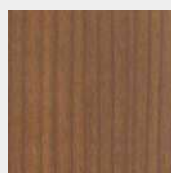

Kirsch 2

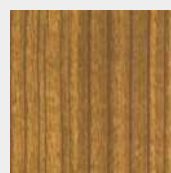

Kirsch 3

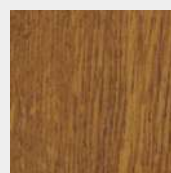

Golden Oak

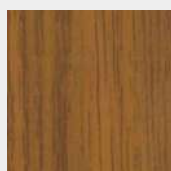

Eiche 2

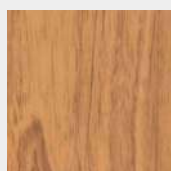

Eiche 4

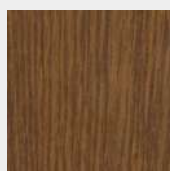

Eiche dunkel

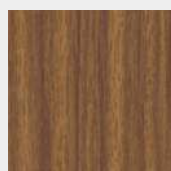

Nuss 1

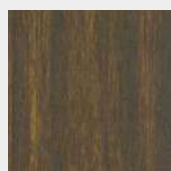

Walnuss dunkel

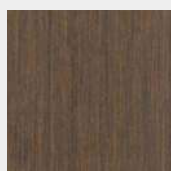

Wenge

LESNI DEKORJI - Serija REFINED

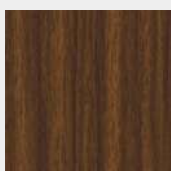

Nussbaum FS

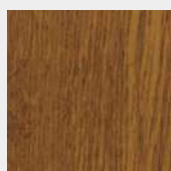

Golden Eiche FS

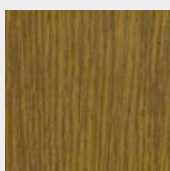

Helle Eiche

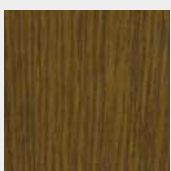

Dunkel Eiche

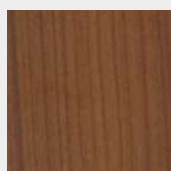

Kirsche

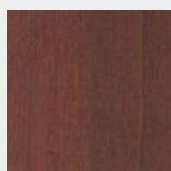

Mahagoni

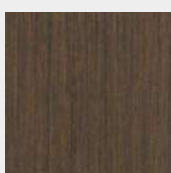

Wenge

ZASTEKLITEV

ORNAMENTNA STEKLA



Katedral Klein. belo



Chinchilla belo

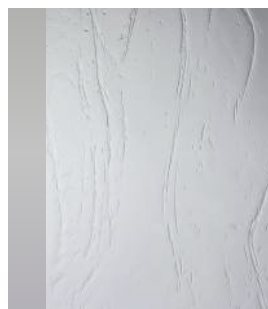

Gothic belo



Altdeutsch K belo

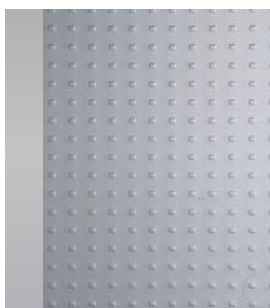

Mastercarre belo



Masterligne belo

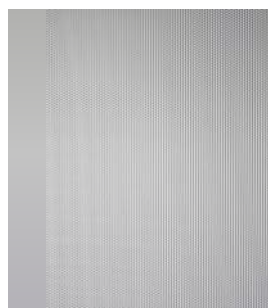

Masterpoint belo

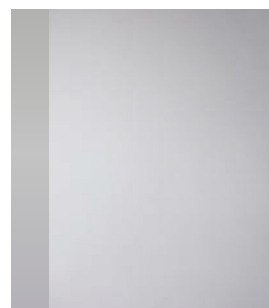

Satinato belo

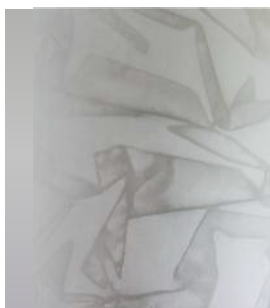

Silk belo

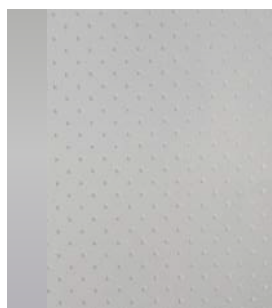

Pave belo

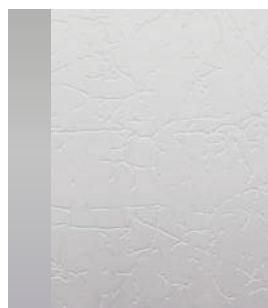

Uadi belo



Nebulosa belo

TOPLOTNO IZOLATIVNA ZASTEKLITEV

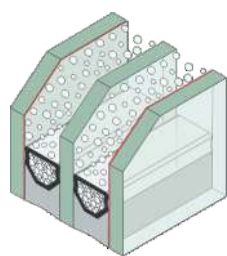

troslojno

PESKANI MOTIVI

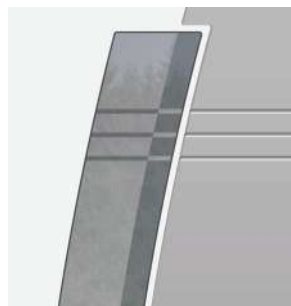

REFINED
AR



Triumph - stran 7



Canary/ AST 100A - stran 6



Levent - stran 7

TREND
New Forest
AT



AT 100 **NF** Attersee



AT 100 **NF** Wolfgangsee
- stran 8



AT 100 **NF** Mondsee
- stran 9



AT 100 **NF** Traunsee
- stran 9



AT 100/ AST 100A **NF** Altausee
- stran 9

TREND
AT



AT 100A/ AST 100A - stran 21



AT 101 - stran 21



AT 102 - stran 21



AT 100 - stran 11



AT 121 - stran 15



AT 131 - stran 12



AT 153A - stran 31



AT 255 - stran 31



AT 264 - stran 17

PREGLED MODELOV



AT 264A/AST 100A - stran 13



AT 265/AST 100A - stran 12



AT 265A - stran 17



AT 266 - stran 13



AT 266A - stran 13



AT 267 - stran 29



AT 801B - stran 18



AT 810/AST 100A - stran 15



AT 843/AST 100A - stran 29



AT 862A/AST 100A - stran 18



AT 863A/AST 100A - stran 26



AT 863B - stran 26



AT 863C - stran 27



AT 864/AST 100A - stran 28



AT 867 - stran 20



AT 875A - stran 29



AT 883/AST 100A - stran 31



AT 887 - stran 30



AT 887B - stran 30



AT 891A - stran 20



AT 894 - stran 11



AT 904 - stran 28



AT 906 - stran 19



AT 906A - stran 19



AT 907 - stran 15



AT 909/AST 100A - stran 14



AT 919 - stran 14



AT 924A/AST 100A - stran 23



AT 934 - stran 25



AT 941A/AST 100A - stran 19



AT 943 - stran 27



AT 944 - stran 22



AT 945A - stran 22



AT 946A - stran 23



AT 946B - stran 23



AT 947/AST 100A - stran 27



AT 948/AST 100A - stran 25

DELUXE
AD



AD 801A - stran 35



AD 801A/AST 100A - stran 35



AD 801B - stran 33



AD 843A - stran 33



AD 863D - stran 35



AD 945/ AST 100A - stran 34



AD 945 - stran 34



AM 132A - stran 38



AM 132A - stran 38



AM 131 - stran 39



AM 134B - stran 37

MODERN
AM



AM 156 - stran 37



AM 170 - stran 39



AM 170/ AST 100A - stran 39

CLASSIC
AC



AC 182A - stran 42



AC 183 - stran 43



AC 183 - stran 43



AC 185/ AST 185 - stran 43



AC 190A/ AST 190 - stran 45



AC 191/ AST 191 - stran 44



AC 194A - stran 44



AC 195A - stran 42



AC 203A - stran 41



AC 207- stran 41



AC 209A - stran 45



AC 209 - stran 45

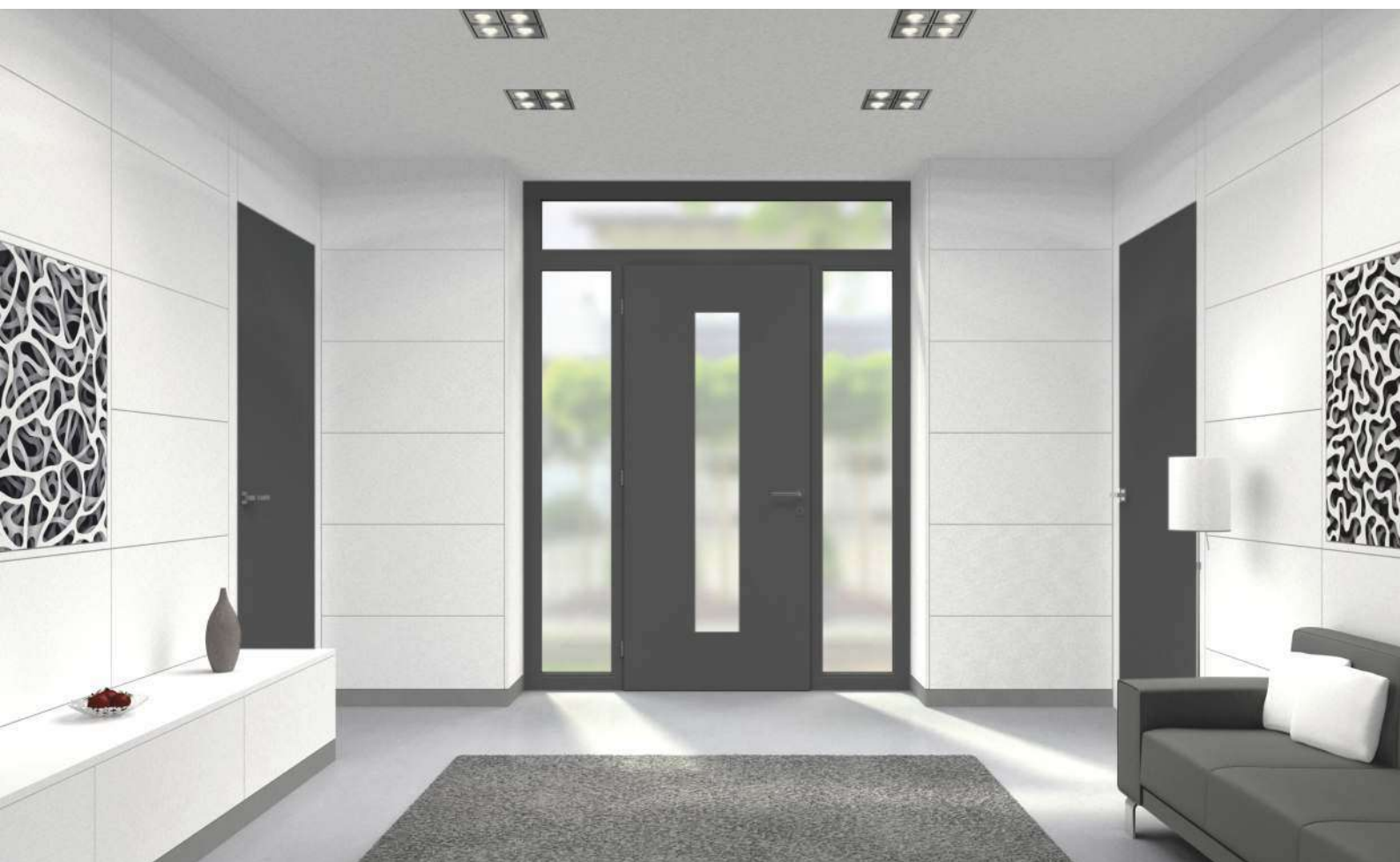

Inles

Proizvodnja, trženje in inženiring d.d.

SI - 1310 Ribnica, Kolodvorska 22
tel.: 01 8377 100, fax: 01 8377 333
e-mail: info@inles.si

RAZSTAVNO PRODAJNI SALON RIBNICA

tel.: 01 8377 111



www.inles.si

POOBLAŠČENI PRODAJALEC: