

# ALUMINIJASTA VHODNA VRATA

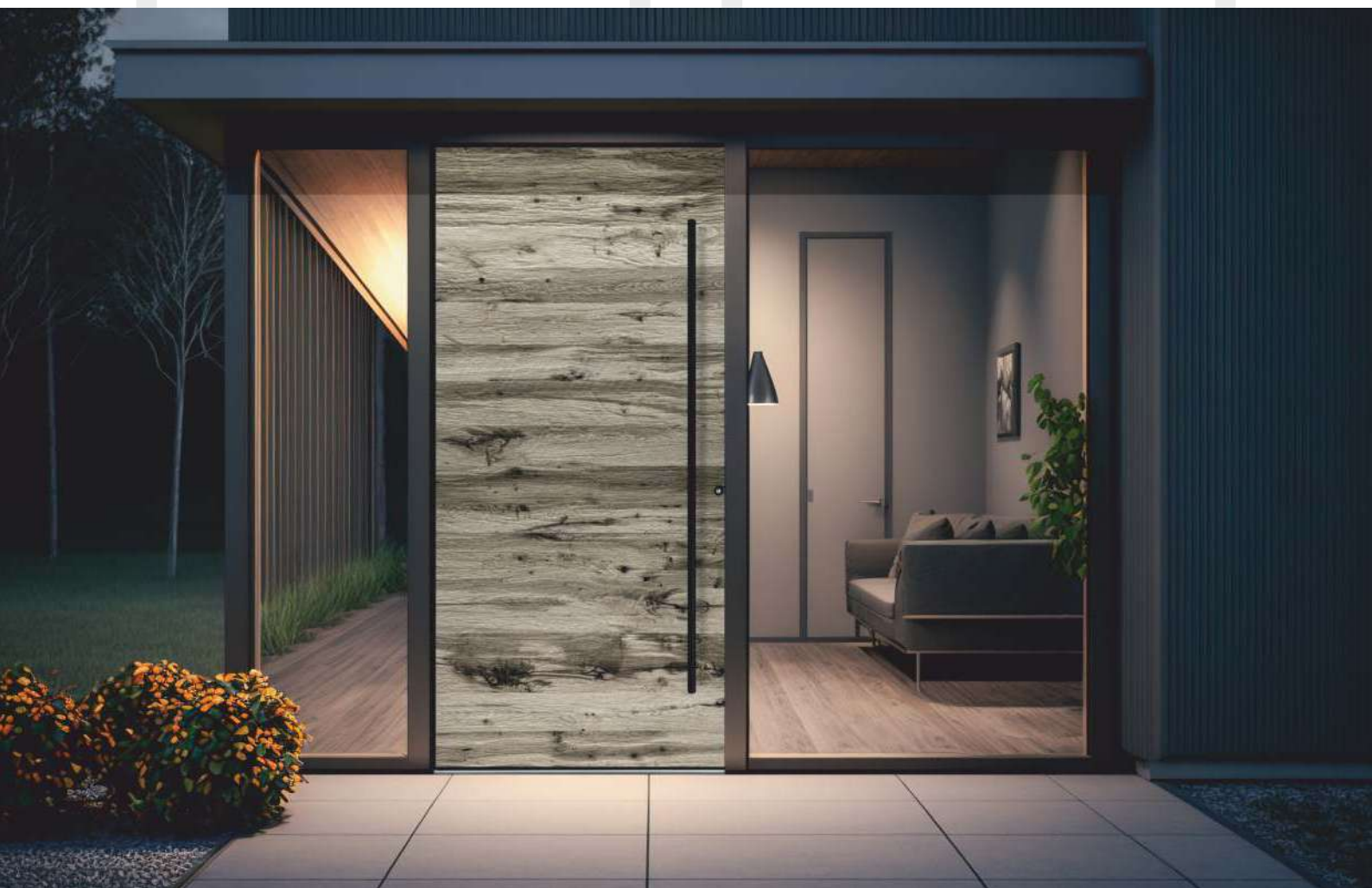

# CLASSIC



Vrata iz serije CLASSIC imajo klasično oblikovano strukturo. Modeli so opremljeni z zasteklitvenimi in okrasnimi okvirčki ter aplikacijami. Vrata lahko opremite s prijemalom in barvo iz inlesove obširne kolekcije ter opremite po svojih željah: led svetila, odpiranje na prstni odtis, hišna številka, varnostna oprema.



AC 203A

Barva HD Eiche 2  
Steklo ornamentno steklo  
Prijemalo 316 866  
poševna pritrditev

Ud (Wm <sup>2</sup> /K)	
EFS	1,3 (Ug 0,7)   BFS   0,94 (Ug 0,5)



AC 207

Barva Granit Nature Fs Metallic  
Steklo ornamentno steklo  
Prijemalo TG 80 poševna pritrditev

Ud (Wm <sup>2</sup> /K)	
EFS	1,2 (Ug 0,7)   BFS   0,94 (Ug 0,5)



AC 182A

Barva Ral 7016 Fs  
Steklo ornamentno steklo  
Prijemalo 316 866 poševna pritrditev

Ud (Wm<sup>2</sup>/K)  
EFS | 1,2 (Ug 0,7) | BFS | 0,92 (Ug 0,5)



AC 195A

Barva Ral 9016 Fs  
Steklo ornamentno steklo  
Prijemalo 316 866 poševna pritrditev

Ud (Wm<sup>2</sup>/K)  
EFS | 1,2 (Ug 0,7) | BFS | 0,91 (Ug 0,5)



### AC 183

Barva Ral 9016 Fs  
Steklo ornamentno steklo  
Prijemalo TG 50 poševna pritrditev

Ud (Wm<sup>2</sup>/K)  
EFS | 1,3 (Ug 0,7) | BFS | 1,0 (Ug 0,5)



### AC 183

Barva Ral 6005 Fs, Ral 9016 Fs  
Steklo ornamentno steklo  
Prijemalo 316 866 schräge Befestigung

Ud (Wm<sup>2</sup>/K)  
EFS | 1,3 (Ug 0,7) | BFS | 1,0 (Ug 0,5)

### AC 185/AST 185

Barva Original Platinum Matt metallic  
Steklo ornamentno steklo  
Prijemalo 316 866 poševna pritrditev

Ud (Wm<sup>2</sup>/K)  
EFS | 1,4 (Ug 0,7) | BFS | 0,95 (Ug 0,5)





AC 191/AST 191

Barva Verdigris Fs Metallic  
 Steklo ornamentno steklo  
 Prijemalo 316 866 poševna pritrditev

Ud (Wm <sup>2</sup> /K)	
EFS   1,3 (Ug 0,7)	BFS   1,1 (Ug 0,5)



AC 194A

Barva Precious Sand Fs Metallic  
 Steklo ornamentno steklo  
 Prijemalo TG 60 poševna pritrditev

Ud (Wm <sup>2</sup> /K)	
EFS   1,3 (Ug 0,7)	BFS   0,97 (Ug 0,5)



### AC 209A

Barva Ral 5014 Fs  
Steklo ornamentno steklo  
Prijemalo 3 16 866 poševna pritrditev

Ud (Wm<sup>2</sup>/K)  
EFS | 1,2 (Ug 0,7) | BFS | 0,92 (Ug 0,5)



### AC 209

Barva Ral 9016 Fs  
Prijemalo TG 50 poševna pritrditev

Ud (Wm<sup>2</sup>/K)  
EFS | 1,2\* (Ug 0,7) | BFS | 0,84\* (Ug 0,5)



### AC 190A/AST 190

Barva Precious Sand Fs Metallic  
Steklo ornamentno steklo  
Prijemalo 3 16 866 poševna pritrditev

Ud (Wm<sup>2</sup>/K)  
EFS | 1,3 (Ug 0,7) | BFS | 1,0 (Ug 0,5)

### SISTEM ADS.SI

- ☐ Profil okvirja iz aluminija debeline 75 ali 95 mm ravnih ali zaobljenih linij. Profil krila iz aluminija je debeline 85 in 75mm.
- ☐ Na sredini profilov za okvir in krilo je termo člen, ki izboljša toplotne karakteristike profila.
- ☐ Polnila iz trde PUR pene oblečene v aluminij z dobrimi toplotno izolativnimi karakteristikami.
- ☐ Pri izvedbah z obojestransko prekritim krilom brez stekelnega izreza ter dimenziji vrat 1100 x 2100 mm, se dosega toplotna prehodnost vrat  $U_d = 0,84 \text{ W/m}^2\text{K}$ , pri enostransko prekritih alu vhodnih vratih se dosega vrednost  $U_d 1,2 \text{ W/m}^2\text{K}$ .



### OKOVJE

- ☐ Kakovostna in praktična nasadila.
- ☐ 5-kratna zapora krila standardno.
- ☐ Razne opcije odpiranja- odpiranje navzven, odpiranje na prstni odtis, električno odpiranje, ...

### ZASTEKLITEV

- ☐ Na izbiro imamo široko paleto toplotno in zvočno izolativnih ter varnostnih stekel.
- ☐ Velika izbira ornamentev in vitražev tudi po vaših željah.
- ☐ Dodelava stekla z različnimi folijami, steklenimi dodatki, peskanjem, ...



### POVRŠINSKA OBDELAVA

- ☐ Prašno lakiranje površin je ekološko prijaznejše in zagotavlja odlično kakovost ter obstojnost obarvane površine.
- ☐ Široka paleta aktualnih standardnih barv.
- ☐ Širok izbor strukturnih ali gladkih barvnih površin aluminija, barve po Ral barvni karti ter imitacije lesnih dekorjev.

## ODPIRANJE

Opiranje navznoter, pogled od **zunaj**



DIN LEVO



DIN DESNO

## PREGLED TIPOV

odpiranje navznoter, pogled od **znotraj**

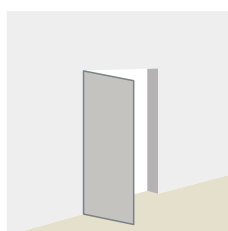

Tip 01

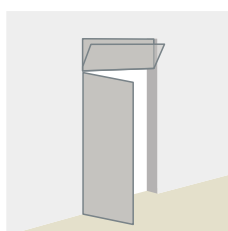

Tip 02/03

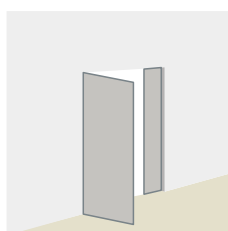

Tip 04

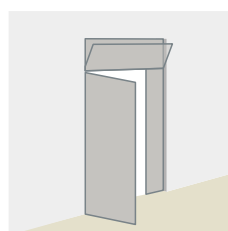

Tip 05/06

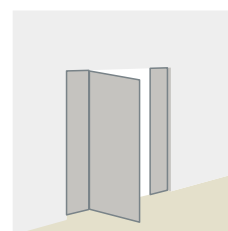

Tip 07

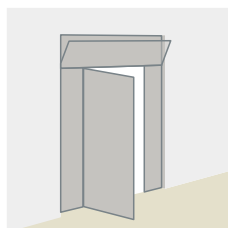

Tip 08/09

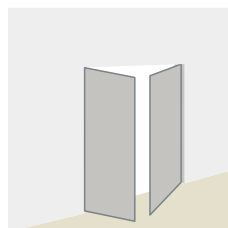

Tip 21

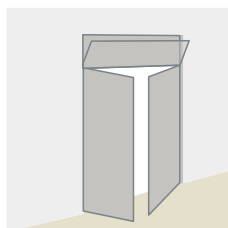

Tip 22/23

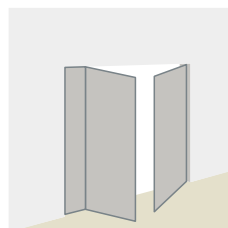

Tip 24

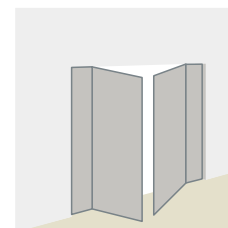

Tip 25

## Aluminijasta vhodna vrata **zunanja stran**

Model AT 100, sistem ADS 75B.SI

poravnana

Barva: krilo Dekor Altholz (Stadelholz-IN), prečna struktura

Okvir: Cast Iron Fs Metallic

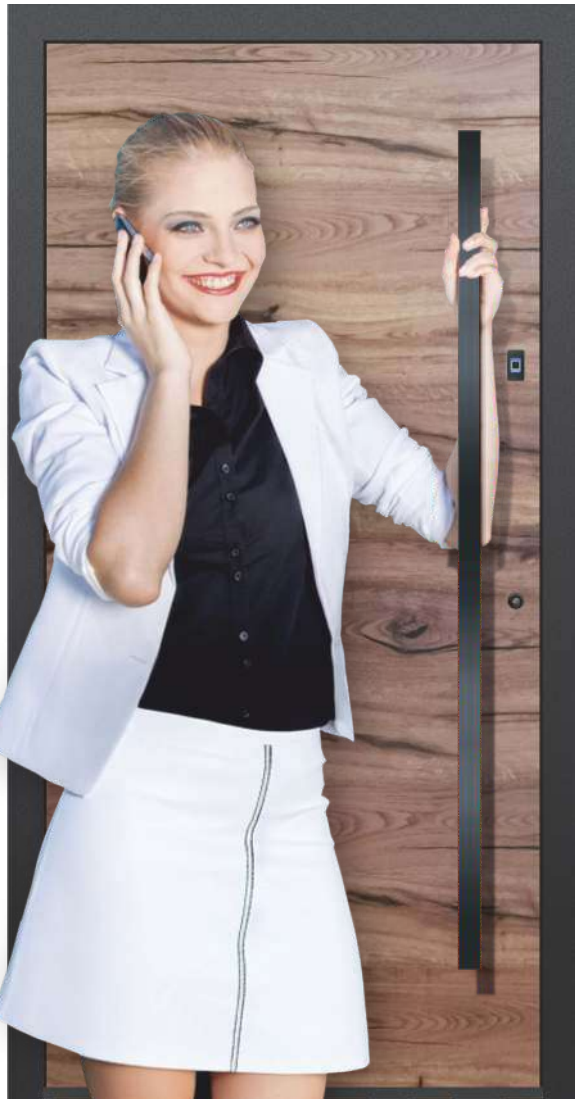

## Les/ aluminij okno **zunanja stran**

INO-HA80-MM poravnana

INO-HA80-F poravnana

Barva Alu: Cast Iron Fs Metallic



## PVC/ aluminij okno **zunanja stran**

Living Top Alu - standardna izvedba

Barva Alu: Cast Iron Fs Metallic

## BEDIENUNGSKOMFORT



Odpiranje na prstni odtis s čitalcem DLine



Odpiranje na prstni odtis s čitalcem Idencom



Prijemalo SG 124 s čitalcem dLine



Smart unilock tipkovnica

## Aluminijasta vhodna vrata **notranja stran**

Model AT 100, Sistem ADS 75B.SI

**poravnana**

Barva: krilo in okvir: Cast Iron Fs Metallic

### Les/ aluminij okno **notranja stran**

INO-HA80-MM **poravnana**

INO-HA80-F - standardna izvedba

Barva Holz: DB 703



### PVC/ aluminij okno **notranja stran**

Living Top Alu - standardna izvedba

Barva PVC: Mattex Shine dark graphite



### LED OSVETLITEV



Prijemalo z Led-osvetlitvijo,  
z zaščito pred praskami  
in aplikacijo iz nerjaveče pločevine



LED-Diode

### DIGITALNO KUKALO



LCD



**ADS 95AK.SI**

oglata oblika okvirja

obojestransko prekrivno krilo

**Ud = 0,81 W/m<sup>2</sup>K**

(Ud vrednost velja za velikost vrat 1230 x 2180 mm, brez izreza za steklo)

**Ud = 0,84 W/m<sup>2</sup>K**

(Ud vrednost velja za velikost vrat 1230 x 2180 mm, brez izreza za steklo)



**ADS 95.SI**

okrogla oblika okvirja

troslojna  
zasteklitev

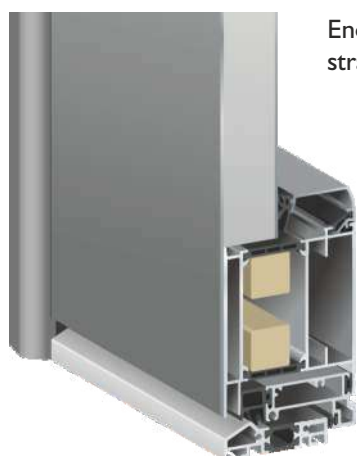

Enostransko - na zunanji strani prekrivno krilo

**Ud = 1,2 W/m<sup>2</sup>K**

(brez izreza za steklo)



Izvedba z vidnim okvirjem na krilu

Pri teh modelih so okvirji kril vidni, tako znotraj kot zunaj.

Na voljo so v vseh različicah vhodnih vrat, razen v seriji Refined, New Forest in Deluxe.



**ADS 75B.SI**

poravnan okvir s krilom  
na zunanji in notranji strani



**Ud = 0,83 W/m<sup>2</sup>K**

(Ud vrednost velja za velikost vrat 1230 x 2180 mm, brez izreza za steklo)

**Ud = 0,87 W/m<sup>2</sup>K**

(Ud vrednost velja za velikost vrat 1230 x 2180 mm, brez izreza za steklo)

obojestransko prekrivno krilo

**Ud = 0,81 W/m<sup>2</sup>K**

(Ud vrednost velja za velikost vrat 1230 x 2180 mm, brez izreza za steklo)

**Ud = 0,84 W/m<sup>2</sup>K**

(Ud vrednost velja za velikost vrat 1230 x 2180 mm, brez izreza za steklo)



**ADS 75.SI**

poravnan okvir s krilom  
samo na zunanji strani

IZVEDBE ZASTEKLITVENIH LETVIC

OVR

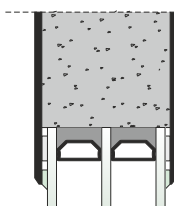

Serija **TREND**

EVR enostransko

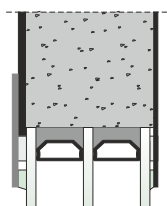

Serija **DELUXE**  
(standardno)

EVR obojestransko

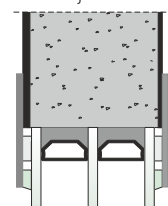

Serija **DELUXE**

AVR

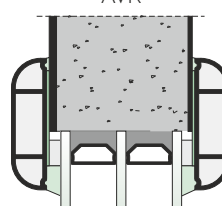

Seriji **MODERN, CLASSIC**

SVR

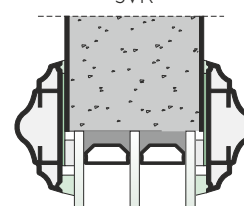

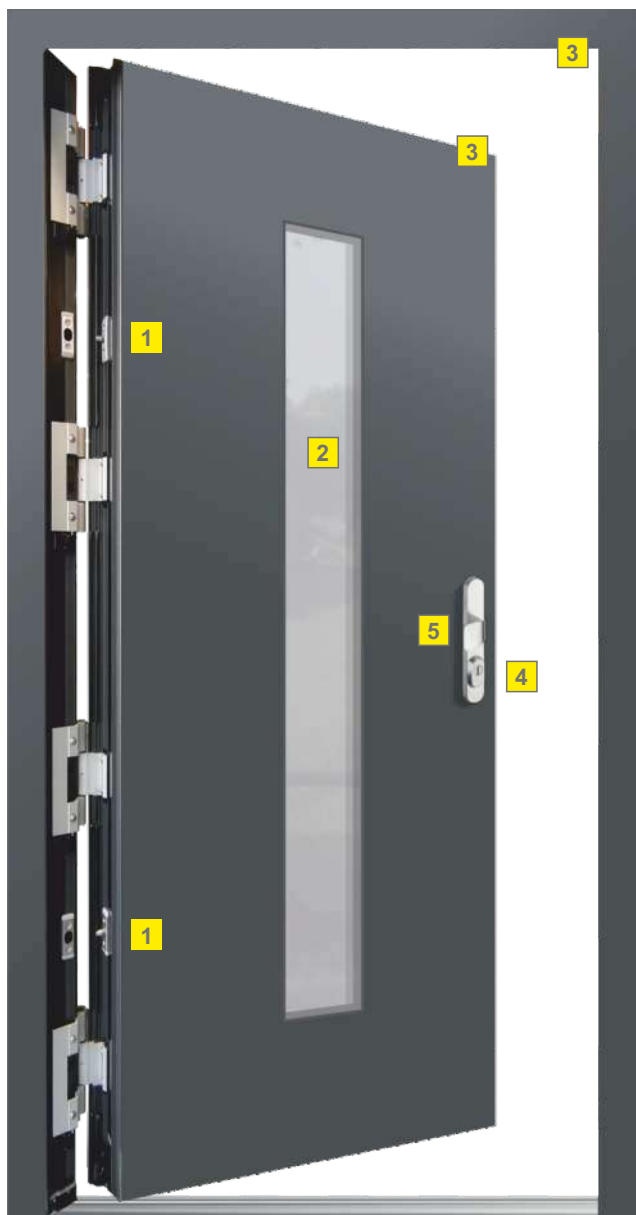

## RC2 – visoka stopnja varnosti

Varnost nepremičnine je bila in ostaja pomemben dejavnik pri izbiri aluminijastih vhodnih vrat.

Aluminijasta vrata poleg visokega kakovostnega standarda že serijsko vključujejo **5-točkovno zaklepanje (zapahi in vrtljivi zatiči)**, kar zagotavlja dodatno zaščito.

Na voljo so tudi v **certificiranih varnostnih razredih RC I in RC2**.

Za še večjo prilagodljivost lahko izbirate med dodatnimi, naprednimi rešitvami zaklepanja ter individualno opremo, ki povečuje udobje uporabe.



## RC2 AUSFÜHRUNG

1 VARNOSTNI ZATIČI



2 VARNOSTNO STEKLO P4A



3 OMEJEVALEC DVIGA KRILA



4 VARNOSTNI CILINDER Z ZAŠČITO PROTI PREVRTANJU

5 VARNOSTNA GARNITURA



**3** TRODIMENZIONALNA NASADILA



**4** POHODNI PRAG

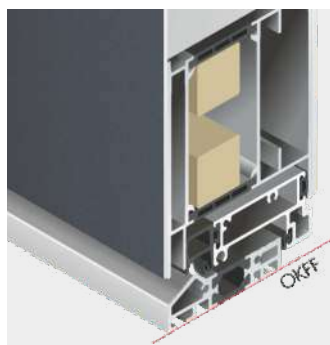

FP1 (standard)

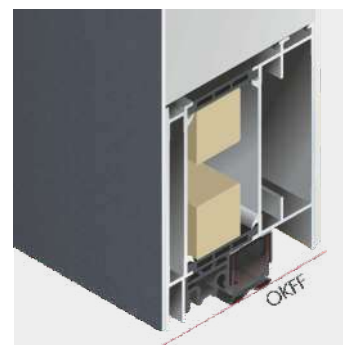

FP5 avtomatsko tesnilo



**ATVE 5**  
**5-kratna ZAPORA**  
 - iz nerjaveče pločevine,  
 z varnostnimi zatiči  
 in kavliji

osnovna varnost  
 serijsko

Mehanski večtokovni sistem zaklepanja, pri katerem osnovno ključavnico in dodatne zapirne elemente (kavelj in varnostni zatič) poslužujemo s pomočjo ključa cilindra



**ATVK 5**  
**5-kratna ZAPORA s komfort funkcijo**  
 - iz nerjaveče pločevine,  
 z varnostnimi zatiči  
 in kavliji

Mehanski večtokovni sistem zaklepanja (kavelj, varnostni zatič)  
 - Z notranje strani je vedno omogočeno odpiranje s kljuko, tudi v primeru zaklenjenih vrat (komfortna funkcija)

- Obvezen prostovrteči cilindar

- Možna samo izvedba kljuka/ bunka ali držalo/ kljuka

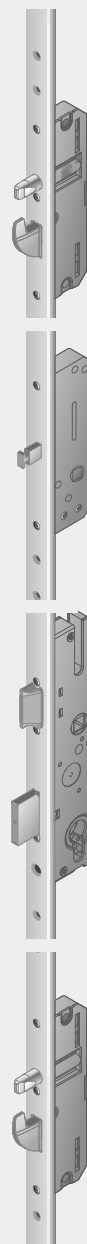
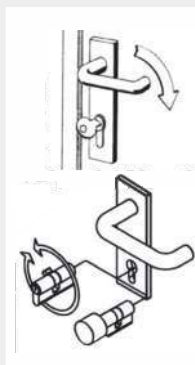

**ATVS 5**  
**5-kratna ZAPORA**  
 - iz nerjaveče pločevine  
 Z varnostnimi zatiči, kavliji  
 ter varnostnim vratnim lovilcem

Sistem večtokovnega zaklepanja (kavelj, varnostni zatič) in varnostnega vratnega lovilca, ki dopušča le režno odpiranje vrat za nekaj cm, tako da ne more vstopiti nepovabljen gost

Od znotraj se vratni lovilce upravlja z vrtljivim gumbom, od zunaj pa s ključem preko glavne ključavnice.



## ELEKTRO-ODPIRALO



## SKRITA NASADILA



Za vrata z odpiranjem navznoter  
 - 100° kot odpiranja



Za vrata z odpiranjem navzven  
 ter za sistem ADS 75B.SI  
 - 180° kot odpiranja



**ATVE A**  
5-kratno varnostno zaklepanje vrat  
AVTOMATSKO,  
MEHANSKO

*Avtomatsko večtočkovno zaklepanje z integrirano samonastavitvijo.*

- 1 Vedno zanesljivo varno. Da so vrata vedno zanesljivo zaklenjena, je vgrajen avtomatski sprožilni zapah.
- 2 Dnevno odklepanje: odhod iz hiše brez ključa. Praktično za vse vsakodnevne situacije, ko želimo objekt za kratek čas zapustiti brez ključa: preprosto izklopite avtomatsko funkcijo s pomočjo drsnika za dnevno odklepanje in sprostite zapah glavne ključavnice na okvirju.

**ATVE A-M**  
5-kratno varnostno zaklepanje vrat  
AVTOMATSKO,  
z motorno funkcijo  
vklj. napajanje

- Zaklepne elemente je mogoče mehansko zakleniti.

- Odklepanje preko domofona, biometrije ... (zapah glavne ključavnice ne sme biti predhodno zaklenjen)

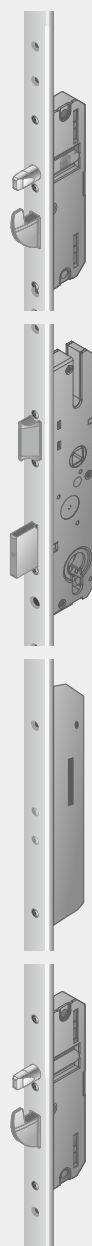

**ATVS 5EA**  
5-kratna zapora Genius

Nerjaveča pločevina, vključno z napajalnikom, z elektromehanskim pogonom, profilni cilindri s prostim tekom z zaščito proti vrtnanju in varnostno funkcijo, vključno s 6 ključi. Pozor: uporabljajte izključno cilindre z oznako FZG!

*Ko so vrata zaprta, se v nočnem načinu samodejno zaklenejo z motorjem (pribl. 3 sek.). Vsi obstoječi zaklepni elementi se iztegnejo. Vrata je mogoče odkleniti ročno s cilindričnim ključem ali samodejno preko zunanjega sistema kontrole dostopa.*

*Ko so vrata popolnoma zaklenjena, je prav tako mogoče od znotraj s kljuko umakniti vse zaporne elemente in tako vrata hitro odpreti.*

**CILINDRIČNI VLOŽKI**



Cilindrični vložek z dvostranskim varnostnim delovanjem in 6 ključi (standardno)



Cilindrični vložek z zaščito proti prevrtanju in 6 ključi



Prosto vrteč cilindrični vložek z zaščito proti prevrtanju, z dvostranskim varnostnim delovanjem in 6 ključi

**SISTEM KONTROLE DOSTOPA (ATVE A-M, ATVS 5EA GENIUS)**



dLine



dLine črne barve



Smart unilock

Smart unilock je inovativna tipkovnica, ki združuje odpiranje preko mobilne aplikacije, prstnega odtisa, kode ali RFID v enem izdelku.



Idencom

## Aluminjasta vhodna vrata **zunanja stran**

Model AT 894, Sistem ADS 95AK.SI

Barva: Cast Iron Fs Metallic, HD Walnuss dunkel

Hišna številka - nerjaveča pločevina

HIŠNA ŠTEVILKA  
- MOTIV NA STEKLU



KUKALO



Medenina polirana / satinirana krom

ZUNANJA OKROGLA ROZETA



Nerjaveča pločevina (standard)      črna

ODKAPNA LETEV



Različni sistemi pisemskih nabiralnikov



WSE 03, Nerjaveča pločevina kot aplikacija



WSE 01, Nerjaveča pločevina



WSE 02, Nerjaveča pločevina

## Aluminijasta vhodna vrata **notranja stran**

Model AT 894, Sistem ADS 95AK.SI

Barva: Ral 9016 FS

Vratno zapiralo TS 5000



### NOTRANJA PRIJEMALA IN ROZETE



### Notranje kljuke I200

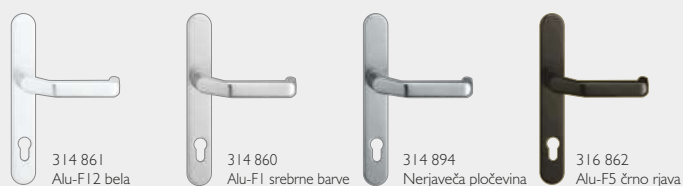

Nasadila

VTOPLJENA PRIJEMALA

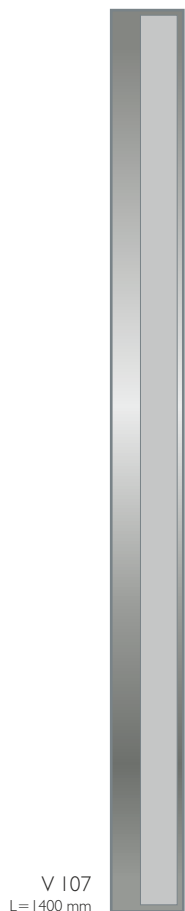

GS-113



GS-88

STOßGRIFFE



SG-49

VTOPLJENO PRIJEMALO



J 137 - vtopljen in poravnan ročaj s krilom vrat

Ral barva  
Vidna odprtina = 45 mm  
Dolžina v mm po želji kupca

PRIJEMALA



Nerjaveča pločevina mat / Les Jatoba

SG 134  
L=1600 mm



Nerjaveča pločevina mat / Les hrast

SG 180  
L=1200 mm



Nerjaveča pločevina mat / Les Jatoba

SG 124  
L=1200 mm

s čitalcem prstnih odtisov dLine



Nerjaveča pločevina mat / Les Jatoba

SPSG 17  
L=1200 mm

z mini-kamero

Led-diode, barva svetlobe bela ohiše iz nerjaveče pločevine

- L 1 (57 x 57 mm)
- L 2 (Ø=41 mm)
- L 3 (Ø=60 mm)
- L 5 (Ø=30 mm)
- L 4 (Ø=35 mm)

Zunanje rozete

- |                     |       |                     |                            |
|---------------------|-------|---------------------|----------------------------|
| Nerjaveča pločevina | Črna  | Nerjaveča pločevina | Črna                       |
|                     |       |                     |                            |
| RRE                 | RRE-S | 316 238             | 316 741 (6)<br>316 742 (9) |

Nerjaveča pločevina  
ZAE 66R  
L=X mm



Nerjaveča pločevina  
310 048  
L=382 mm



Nerjaveča pločevina  
310 047  
L=382 mm

KLJUKE



Alu - FI srebrne barve  
314 866



Alu - FI srebrne barve  
314 863

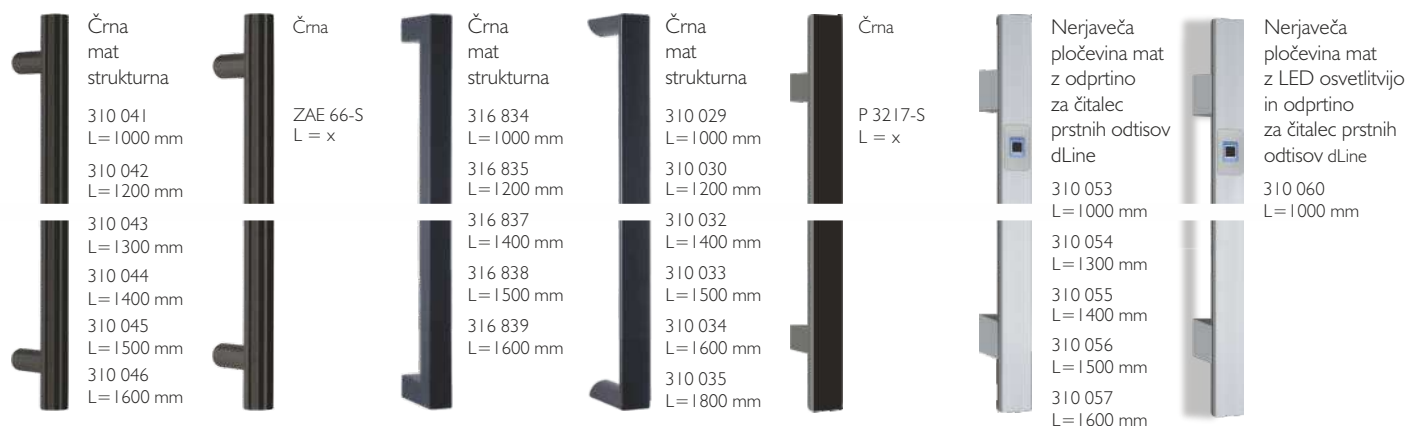
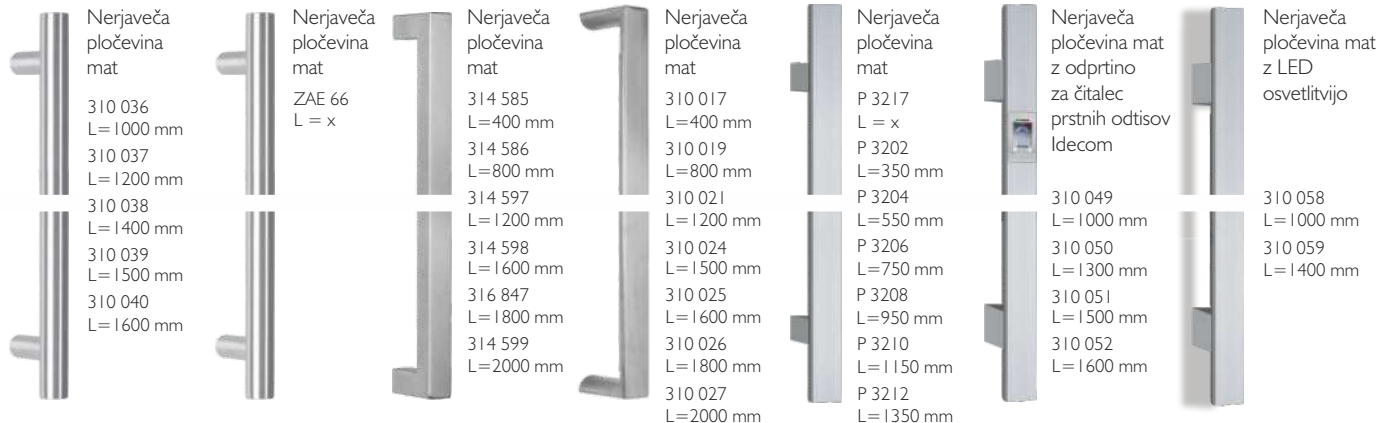

### ZAŠČITA PRED PRASKAMI



Nerjaveča pločevina 310 174    Nerjaveča pločevina 310 179    Nerjaveča pločevina 310 184    Nerjaveča pločevina 316 668    Nerjaveča pločevina 316 671    Nerjaveča pločevina 316 662    Nerjaveča pločevina 316 665

Ponudba barv za aluminijaste površine  
IZBOR

MASTER COLLECTION strukturne, metalik



Iceberg Blue  
Feinstruktur Metallic



Rumbling Sky  
Feinstruktur Metallic



Night Grey  
Feinstruktur Metallic

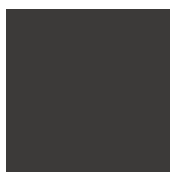

Cast Iron  
Feinstruktur Metallic



Russet Copper  
Feinstruktur Metallic



Brown  
Feinstruktur Metallic

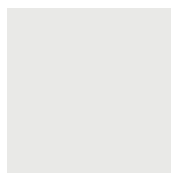

Artic Ice  
Feinstruktur Metallic

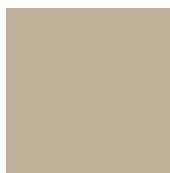

Precious Sand  
Feinstruktur Metallic



Verdigris  
Feinstruktur Metallic



Granit Nature  
Feinstruktur Metallic



Volcanic Ash  
Feinstruktur Metallic



Elves Bench  
Feinstruktur Metallic

ANODIZING COLLECTION mat, metalik

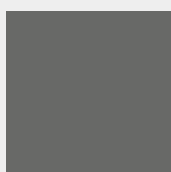

ORIGINAL PLATINIUM  
Matt Metallic

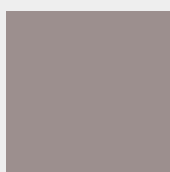

SILVER DREAM  
Matt Metallic

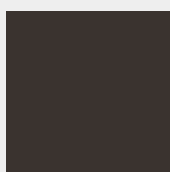

CARBON NIGHT  
Matt Metallic

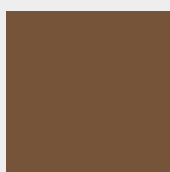

DARK COPPER  
Matt Metallic



SIMPLY COPPER  
Matt Metallic



GREY BD  
Matt Metallic

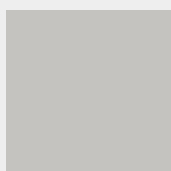

GSPED 0  
Matt

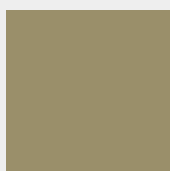

GSPED 1  
Matt

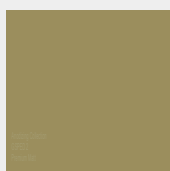

GSPED 2  
Matt



GSPED 3  
Matt

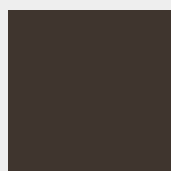

GSPED 4  
Matt



NOBLE BRONZE  
Matt Metallic

RAL barve mat, strukturne, metalik, gladke

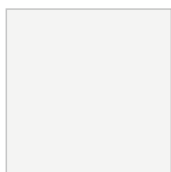

RAL 9016  
Feinstruktur



RAL 7040  
Feinstruktur

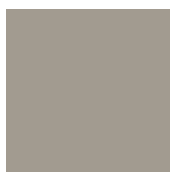

RAL 7039  
Feinstruktur



RAL 7012  
Feinstruktur



RAL 7015  
Feinstruktur



RAL 7016  
Feinstruktur

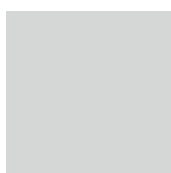

RAL 9006  
Metallic glatt



RAL 9007  
Metallic Feinstruktur



DB 703  
Metallic Feinstruktur



RAL 7021  
Feinstruktur



RAL 9005  
Feinstruktur



RAL 8019  
Feinstruktur

DEKOR - VIDEZ KAMNA



Dekor Concrete  
Beton optik



Dekor Beton dunkel

LESNI DEKOR



Dekor Altholz  
(Stadelholz-1N)

FURNIRJI - Serija TREND AT 100 **New Forest**



Dekor ATTERSEE



Dekor  
WOLFGANGSEE



Dekor TRAUNSEE

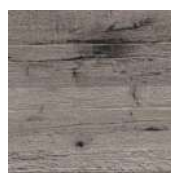

Dekor MONDSSEE



Dekor ALTAUSSEE

LESNI DEKORJI (strukturni)

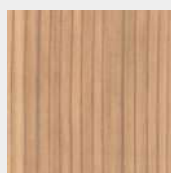

Douglas 6

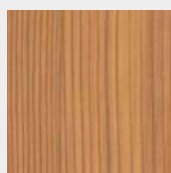

Douglas 7

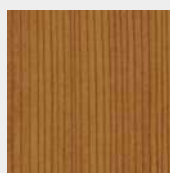

Douglas 2

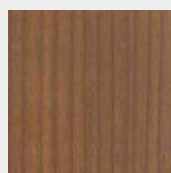

Kirsch 2

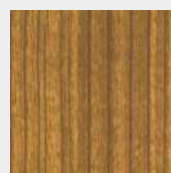

Kirsch 3

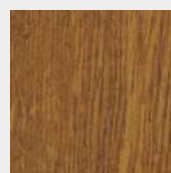

Golden Oak

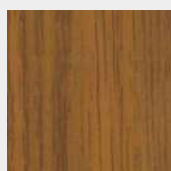

Eiche 2

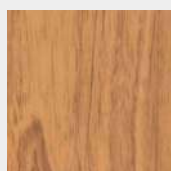

Eiche 4

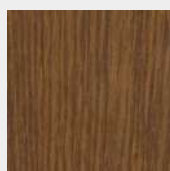

Eiche dunkel

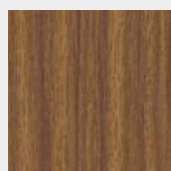

Nuss 1

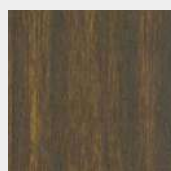

Walnuss dunkel

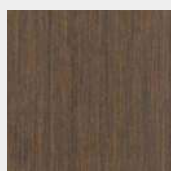

Wenge

LESNI DEKORJI - Serija REFINED

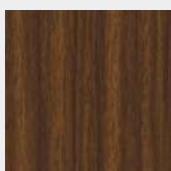

Nussbaum FS

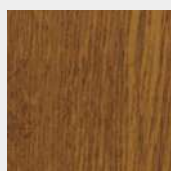

Golden Eiche FS

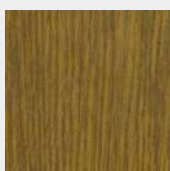

Helle Eiche



Dunkel Eiche

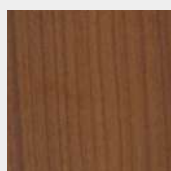

Kirsche

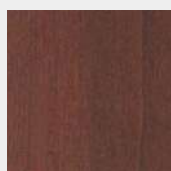

Mahagoni

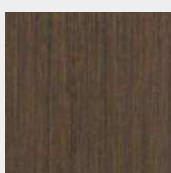

Wenge

# ZASTEKLITEV

## ORNAMENTNA STEKLA



Katedral Klein. belo



Chinchilla belo

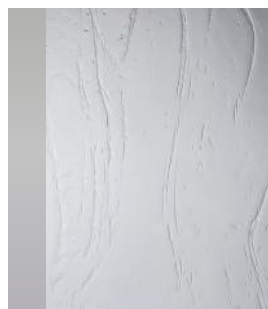

Gothic belo



Altdeutsch K belo

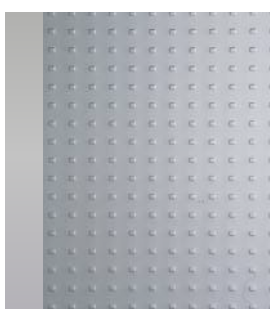

Mastercarre belo



Masterligne belo

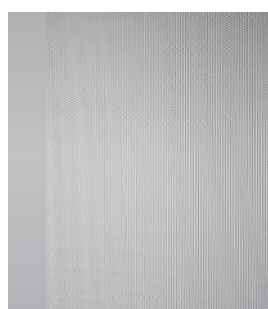

Masterpoint belo



Satinato belo

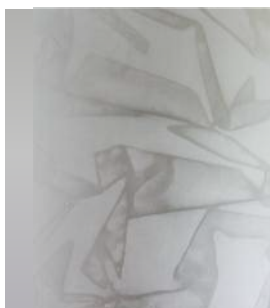

Silk belo

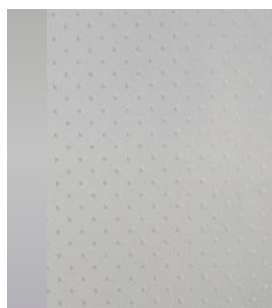

Pave belo

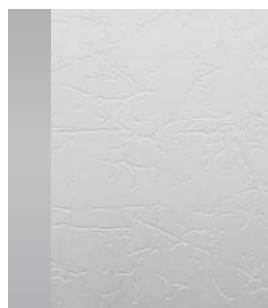

Uadi belo



Nebulosa belo

## TOPLOTNO IZOLATIVNA ZASTEKLITEV

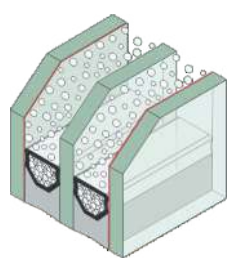

troslojno

## PESKANI MOTIVI

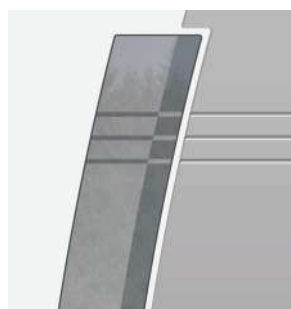

REFINED  
**AR**



Triumph - stran 7



Canary/ AST 100A - stran 6



Levent - stran 7

TREND  
New Forest  
**AT**



AT 100 **NF** Attersee



AT 100 **NF** Wolfgangsee  
- stran 8



AT 100 **NF** Mondsee  
- stran 9



AT 100 **NF** Traunsee  
- stran 9



AT 100/ AST 100A **NF** Altausee  
- stran 9

TREND  
**AT**



AT 100A/ AST 100A - stran 21



AT 101 - stran 21



AT 102 - stran 21



AT 100 - stran 11



AT 121 - stran 15



AT 131 - stran 12



AT 153A - stran 31



AT 255 - stran 31



AT 264 - stran 17

# PREGLED MODELOV



AT 264A/AST 100A - stran 13



AT 265/AST 100A - stran 12



AT 265A - stran 17



AT 266 - stran 13



AT 266A - stran 13



AT 267 - stran 29



AT 801B - stran 18



AT 810/AST 100A - stran 15



AT 843/AST 100A - stran 29



AT 862A/AST 100A - stran 18



AT 863A/AST 100A - stran 26



AT 863B - stran 26



AT 863C - stran 27



AT 864/AST 100A - stran 28



AT 867 - stran 20



AT 875A - stran 29



AT 883/AST 100A - stran 31



AT 887 - stran 30



AT 887B - stran 30



AT 891A - stran 20



AT 894 - stran 11



AT 904 - stran 28



AT 906 - stran 19



AT 906A - stran 19



AT 907 - stran 15



AT 909/AST 100A - stran 14



AT 919 - stran 14



AT 924A/AST 100A - stran 23



AT 934 - stran 25



AT 941A/AST 100A - stran 19



AT 943 - stran 27



AT 944 - stran 22



AT 945A - stran 22



AT 946A - stran 23



AT 946B - stran 23



AT 947/AST 100A - stran 27



AT 948/AST 100A - stran 25

DELUXE  
AD



AD 801A - stran 35



AD 801A/AST 100A - stran 35



AD 801B - stran 33



AD 843A - stran 33

MODERN  
AM



AD 863D - stran 35



AD 945/ AST 100A - stran 34



AD 945 - stran 34



AM 132A - stran 38



AM 132A - stran 38



AM 131 - stran 39



AM 134B - stran 37



AM 156 - stran 37



AM 170 - stran 39



AM 170/ AST 100A - stran 39

CLASSIC  
AC



AC 182A - stran 42



AC 183 - stran 43



AC 183 - stran 43



AC 185/ AST 185 - stran 43



AC 190A/ AST 190 - stran 45



AC 191/ AST 191 - stran 44



AC 194A - stran 44



AC 195A - stran 42



AC 203A - stran 41



AC 207- stran 41



AC 209A - stran 45



AC 209 - stran 45

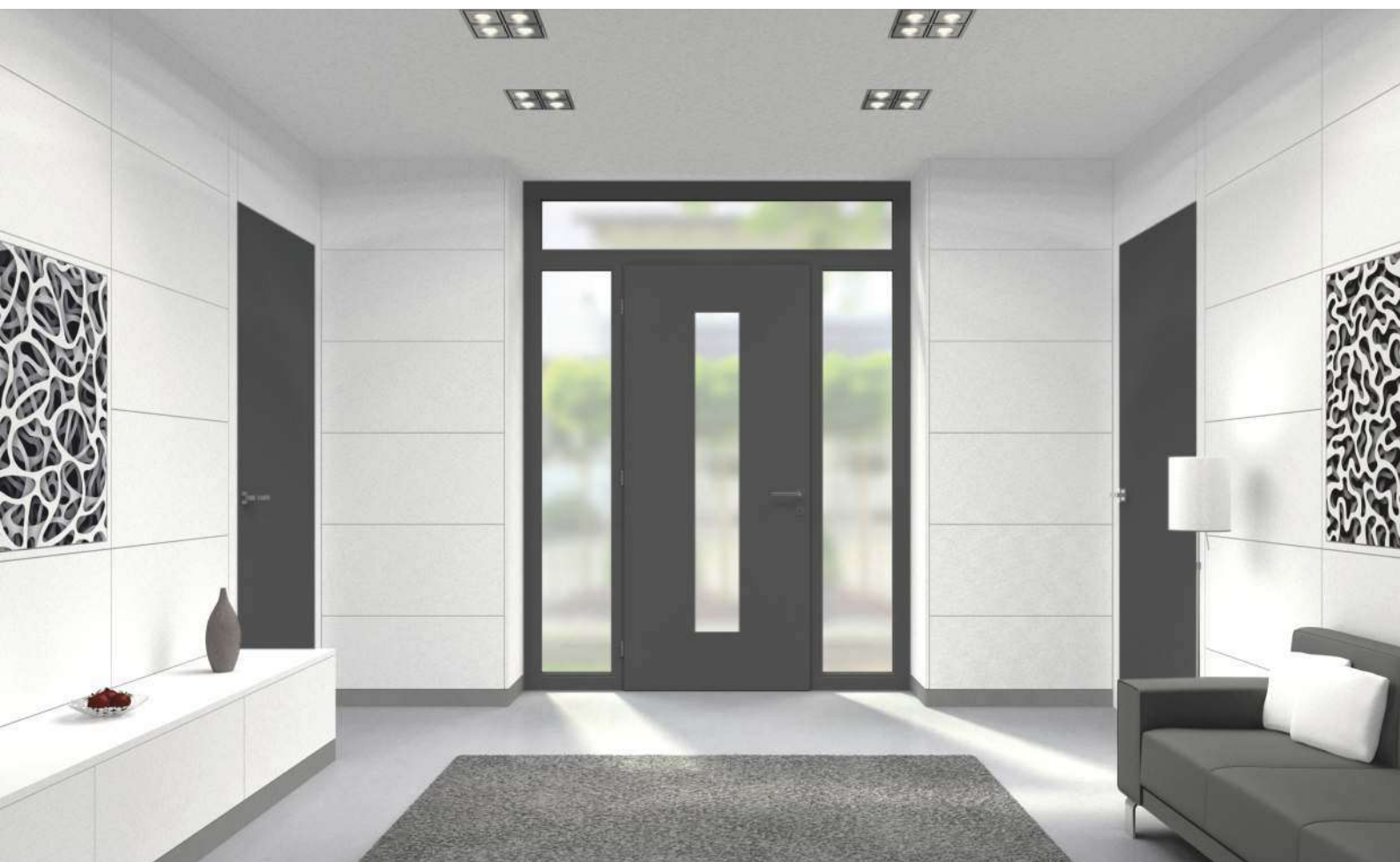

## Inles

Proizvodnja, trženje in inženiring d.d.

SI - 1310 Ribnica, Kolodvorska 22  
tel.: 01 8377 100, fax: 01 8377 333  
e-mail: info@inles.si

RAZSTAVNO PRODAJNI SALON RIBNICA

tel.: 01 8377 111



[www.inles.si](http://www.inles.si)

POOBLAŠČENI PRODAJALEC: