

ALUMINIUM-HAUSTÜREN



 **ISARHOLZ**®

Aluminium Haustür **aussen**

Modell AT 100, System ADS 75B.SI

außen flächenbündig

Farbe: Flügel Dekor Altholz (Stadelholz- IN), querfurniert

Rahmen: Cast Iron Fs Metallic



Holz/Alu Fenster **außen**

INO-HA80-MM **flächenbündig**

INO-HA80-F **flächenbündig**

Farbe Alu: Cast Iron Fs Metallic

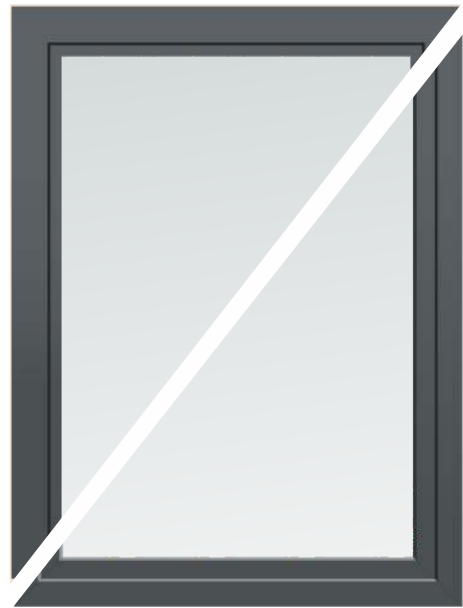

Kunststoff/Alu Fenster **außen**

Living Top Alu flächenversetzt

Farbe Alu: Cast Iron Fs Metallic

BEDIENUNGSKOMFORT



Öffnung der Haustüre
mit dLine Fingerprint



Öffnung der Haustüre
mit Idencom Fingerprint



Griff SG 124 mit integriertem
Fingerprint dLine



Smart unilock
Multifunktions-Keypad

Aluminium Haustür innen

Modell AT 100, System ADS 75B.SI

innen flächenbündig

Farbe: Flügel und Rahmen: Cast Iron Fs Metallic



Holz/Alu Fenster innen

INO-HA80-MM flächenbündig

INO-HA80-F flächenversetzt

Farbe Holz: DB 703



Kunststoff/Alu Fenster innen

Living Top Alu flächenversetzt

Farbe Kunststoff: Mattex Shine dark graphite

LED LEUCHTEN



Außengriff mit integriertem Led-Leucht, Kratzerschutz und Edelstahl Applikation



LED-Diode

DIGITALER TÜRSPION



mit LCD - Bildschirm

SYSTEM AUSFÜHRUNGEN



ADS 95AK.SI
Eckig Rahmen

Beidseitig flügelüberdeckende Ausführung

Ud = 0,81 W/m²K

(Ud Berechnung für Türgröße 1230 x 2180 mm, ohne Glasausschnitt)

Ud = 0,84 W/m²K

(Ud Berechnung für Türgröße 1100 x 2100 mm, ohne Glasausschnitt)



ADS 95.SI
Rund Rahmen

Dreifach
Verglasung

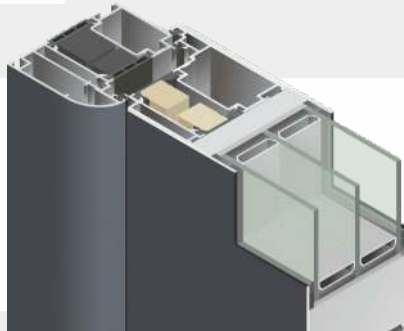

Einseitig
flügelüberdeckende
Ausführung aussen

Ud = 1,2 W/m²K
(ohne Glasausschnitt)



**Ausführungen mit
sichtbarem Flügel**

Bei diesen Modellen sind die Flügel sichtbar und dieses sowohl innen als auch außen. Sie sind in allen Haustürenausführungen außer in der Deluxe Serie erhältlich.



ADS 75B.SI

Innen und außen
flächenbündig

$U_d = 0,83 \text{ W/m}^2\text{K}$

(U_d Berechnung für Türgröße 1230 x 2180 mm, ohne Glasausschnitt)

$U_d = 0,87 \text{ W/m}^2\text{K}$

(U_d Berechnung für Türgröße 1100 x 2100 mm, ohne Glasausschnitt)

Beidseitig flügelüberdeckende Ausführung

$U_d = 0,81 \text{ W/m}^2\text{K}$

(U_d Berechnung für Türgröße 1230 x 2180 mm, ohne Glasausschnitt)

$U_d = 0,84 \text{ W/m}^2\text{K}$

(U_d Berechnung für Türgröße 1100 x 2100 mm, ohne Glasausschnitt)



ADS 75.SI

außen flächenbündig

VERGLASUNGSRAHMEN AUSFÜHRUNGEN

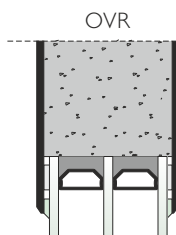

Serie TREND

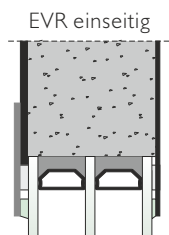

Serie DELUXE
(Standardausführung)

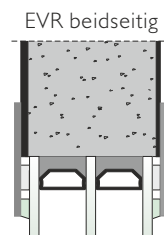

Serie DELUXE

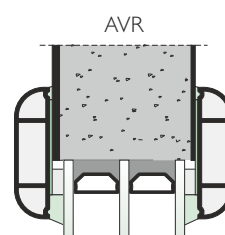

Serien MODERN, CLASSIC

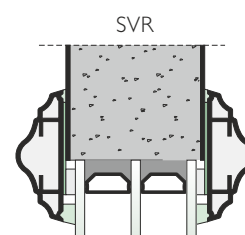

RC2 wir beraten Sie dazu gerne ausführlich.

Die Sicherheit einer Immobilie war und ist ein aktuelles Thema bei dem Kauf von Alu-Haustüren. Ergänzend zu dem in diesem Sinne hohen Qualitätsstandard der Alu-Haustüren als solches, sind diese mit **5-fach Verriegelung (Bolzen und Schwenkriegel)** als **Standardverriegelung** ausgerüstet. Des Weiteren erhalten Sie ISARHOLZ-Alu-Haustüren in den **zertifizierten Sicherheitsstufen RCI und RC2**. Darüber hinaus stehen Ihnen weitere detailrelevante Verriegelungen zur Verfügung. Für einen hohen Bedienungskomfort erhalten Sie individuelle Einrichtungen.

Über die **Sicherheitseinrichtungen für ISARHOLZ-Holz- und Holz/Alu- und Kunststoff-Haustüren** informiert Sie Ihr ISARHOLZ-Fachbetrieb.



RC2 AUSFÜHRUNG

1 SICHERUNGSBOLZEN



2 SICHERHEITSGLAS P4A



3 FALZLUFTBEGRENZER



4 SICHERHEITSPROFILZYLINDER MIT ANBOHRSCHUTZ

5 SICHERHEITSGARNITUR



3 DREITEILIGES TÜRBÄNDER



Serienmäßig bis Türhöhe 2150 mm
mit 3 Bänder und ab 2151 mm
mit 4 Bänder gefertigt (standard)

4 TÜRSCHWELLEN

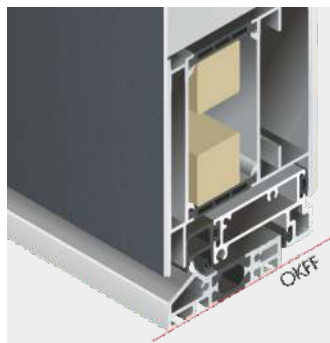

FPI (standard)

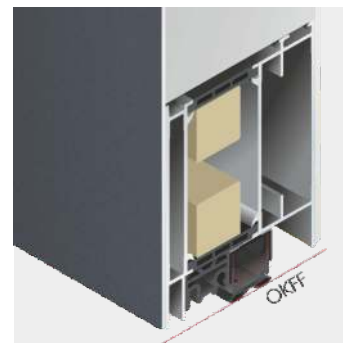

FP5 automatische Türabdichtung

SICHERHEITSTÜRVERSCHLÜßE



ATVE 5
5-fach Verriegelung
 - Edelstahl
 mit Bolzen und
 Schwenkriegel

**Serienmäßige
 Sicherheit**

- mechanische
 Mehrfachverriegelung

- 5-fach Schutz durch
 einen Hauptriegel,
 2 Bolzen und
 2 Schwenkriegel



ATVK 5
**5-fach Verriegelung
 mit Komfortfunktion**
 - Edelstahl,
 mit Bolzen und
 Schwenkriegel

- Mechanisch Öffnen der Tür
 über Drücker immer möglich
 (Komfortöffnung)
- Ein Freilaufzylinder oder ein
 Knaufzylinder erforderlich
- Möglich nur in der Kombination
 außen Stoßgriff - innen Drücker
 (Drücker außenseitig nicht
 möglich)

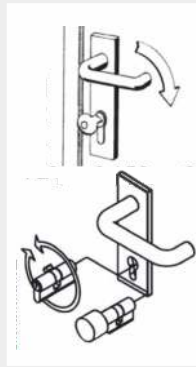

Komfortfunktion
 = Schnellöffnung
 von innen über
 den Drücker

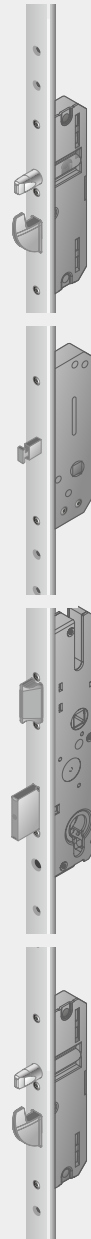

ATVS 5
5-fach Verriegelung
 - Edelstahl
 mit Bolzen,
 Schwenkriegel
 und **Türfänger**

Der spezialgehärtete Sperrbügel
 sorgt dafür, dass sich die Tür
 nur einen Spalt breit öffnet, sodass
 sich kein ungebeter Gast zwischen
 Tür und Stock durchzwängen kann.

Von innen lässt sich das Fängerschloss
 einfach über einen Drehknopf
 bedienen, von außen wird es mit
 dem Schlüssel über das Hauptschloss
 betätigt.



ELEKTRO-TÜRÖFFNER



VERDECKTLIEGENDE TÜRBÄNDER



Für nach innen öffnende
 Türen - 100° Öffnungswinkel



Für nach außen öffnende
 Türen und ADS 75B.SI - 180°

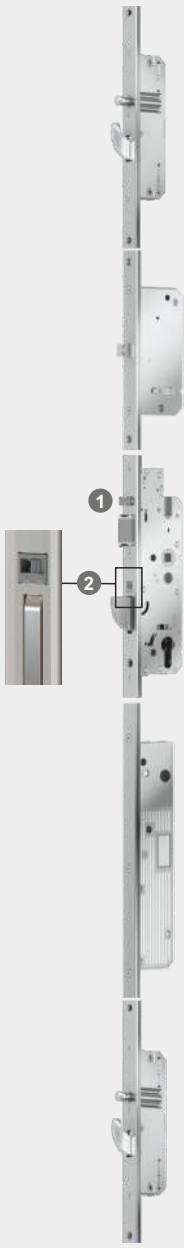

ATVE A
5-fach Sicherheits-
türverschuß
AUTOMATIK,
MECHANISCH

Automatik-Mehrfachverriegelung mit integrierter Selbstjustierung

- 1 Jederzeit verlässlich sicher. Damit die Tür jederzeit verlässlich verriegelt, die Automatikauslösefalle integrieren.
- 2 Tagesentriegelung: ohne Schlüssel aus dem Haus. Praktisch für alle Alltagssituationen, in denen man das Gebäude kurzzeitig schlüssellos verlassen möchte: einfach die Automatikfunktion mittels Schieber der Tagesentriegelung deaktivieren und die Hauptschlossfalle am Rahmenteil freigeben.

ATVE A-M
5-fach Sicherheits-
türverschuß
AUTOMATIK,
mit motorischer
Funktion,
 inkl. Netzteil

- Verriegelungselementen lassen sich mechanisch verriegeln

- Entriegelung über die Rücksprechanlage, Biometrie, ... (der Riegel des Hauptschlusses darf nicht vorgeschlossen sein)

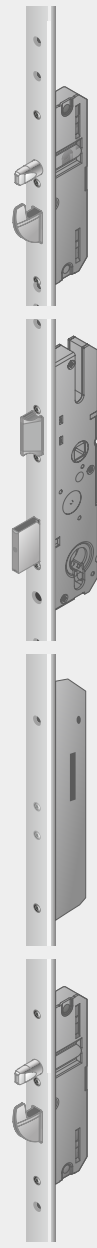

ATVS 5EA
5-fach Verriegelung Genius

- Edelstahl, inkl. Netzteil mit elektromechanischem Antrieb, Freilauf-Profilzylinder mit Aufbohrschutz und Gefahrenfunktion einschließlich 6 Schlüsseln.

Achtung: Ausschließlich Zylinder mit Kennzeichnung FZG verwenden!

*Sobald die Tür geschlossen ist, erfolgt im Nachtbetrieb eine automatische Verriegelung durch den Motor (ca. 3 sec.). Alle vorhandenen Verschlusselemente werden herausgefahren.
 Die Tür kann manuell durch den Zylinderschlüssel oder automatisch über ein externes Zutrittskontrollsystem entriegelt werden.
 Wenn die Tür vollständig verriegelt ist, ist es auch möglich, von innen über den Drücker alle Riegelemente zurückzufahren und die Tür so schnell zu öffnen.*

PROFILZYLINDER



Profilzylinder mit Not- und Gefahrenfunktion und 6 Schlüsseln (standard)



Profilzylinder mit Aufbohrschutz und 6 Schlüsseln



Freilauf-Profilzylinder mit Aufbohrschutz und Gefahrenfunktion einschließlich 6 Schlüsseln

ZUTRITTSKONTROLLESYSTEM (ATVE A-M, ATVS 5EA GENIUS)



dLine



dLine Schwarz



Smart unilock

Das smart unilock ist ein innovatives Keypad welches Öffnung per Handy App, Fingerabdruck, code oder RFID in einem Produkt vereint.



Idencom

Aluminium Haustür **aussen**

Modell AT 894, System ADS 95AK.SI

Farbe: Cast Iron Fs Metallic, HD Walnuss dunkel

Hausnummer Edelstahl

HAUSNUMMER MOTIVGLAS



TÜRSPION



Messing poliert / Satin Chrom

AUSSEN RUNDROSETTE



Edelstahl
(standard)

schwarz



WETTERSCHENKEL



Briefkasten-Systeme



WSE 03, Edelstahl Applikation



WSE 01, Edelstahl



WSE 02, Edelstahl

Aluminium Haustür innen

Modell AT 894, System ADS 95AK.SI

Farbe: Ral 9016 FS

Türschließer TS 5000



INNENGRIFFE, INNENROSETTE



Dreiteilige Rolltürbänder

Innengriffe I 200



GRIFFSCHALEN



GS-113

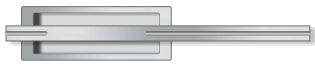

GS-88



STOßGRIFFE



SG-49

INTEGRIERTE GRIFFLEISTE

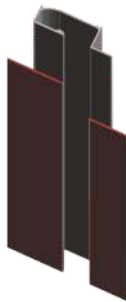

J 137 flächenbündig

integrierte Griffleiste
- Ral farbe; sichtbarer
Schlitz = 45mm
Länge in mm nach
Wunsch

V 107
L=1400 mm

AUßENGRIFFE



Edelstahl
matt /
Holz Jatoba

SG 134
L=1600 mm



Edelstahl
matt /
Holz Eiche

SG 180
L=1200 mm



Edelstahl
matt /
Holz Jatoba

SG 124
L=1200 mm

Mit integriertem
Fingerprint
dLine



Edelstahl
matt /
Holz Jatoba

SPSG 17
L=1200 mm

Mit Mini-
Kamera

LED-DIODEN, Licht farbe weiß,
Led-Diodelampe Edelstahl

□ L 1 (57 x 57 mm) ○ L 2 (Ø=41 mm)

○ L 3 (Ø=60 mm) ○ L 5 (Ø=30 mm)

● L 4 (Ø=35 mm)

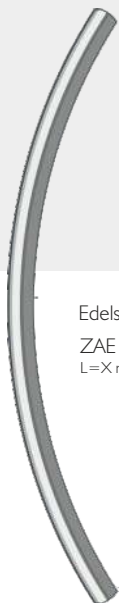

Edelstahl matt
ZAE 66R
L=X mm



Edelstahl matt
310 048
L=382 mm



Edelstahl matt
310 047
L=382 mm

AUßENROSETTE

Edelstahl Schwarz Edelstahl Edelstahl Schwarz



RRE

RRE-S

316 238

316 239 (6)
316 240 (9)

316 741 (6)
316 742 (9)













DRÜCKERGARNITUR, WECHELGARNITUR

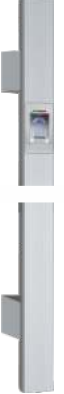

Alu - FI silber
314 866



Alu - FI silber
314 863

 <p>Edelstahl matt 310 036 L=1000 mm 310 037 L=1200 mm 310 038 L=1400 mm 310 039 L=1500 mm 310 040 L=1600 mm</p>	 <p>Edelstahl matt ZAE 66 L = x</p>	 <p>Edelstahl matt 314 585 L=400 mm 314 586 L=800 mm 314 597 L=1200 mm 314 598 L=1600 mm 316 847 L=1800 mm 314 599 L=2000 mm</p>	 <p>Edelstahl matt 310 017 L=400 mm 310 019 L=800 mm 310 021 L=1200 mm 310 024 L=1500 mm 310 025 L=1600 mm 310 026 L=1800 mm 310 027 L=2000 mm</p>	 <p>Edelstahl matt P 3217 L = x P 3202 L=350 mm P 3204 L=550 mm P 3206 L=750 mm P 3208 L=950 mm P 3210 L=1150 mm P 3212 L=1350 mm</p>	 <p>Edelstahl matt mit Fräsung für Fingerscan Idecom 310 049 L=1000 mm 310 050 L=1300 mm 310 051 L=1500 mm 310 052 L=1600 mm</p>	 <p>Edelstahl matt mit Led 310 058 L=1000 mm 310 059 L=1400 mm</p>
 <p>Schwarz matt Struktur 310 041 L=1000 mm 310 042 L=1200 mm 310 043 L=1300 mm 310 044 L=1400 mm 310 045 L=1500 mm 310 046 L=1600 mm</p>	 <p>Schwarz ZAE 66-S L = x</p>	 <p>Schwarz matt Struktur 316 834 L=1000 mm 316 835 L=1200 mm 316 837 L=1400 mm 316 838 L=1500 mm 316 839 L=1600 mm</p>	 <p>Schwarz matt Struktur 310 029 L=1000 mm 310 030 L=1200 mm 310 032 L=1400 mm 310 033 L=1500 mm 310 034 L=1600 mm 310 035 L=1800 mm</p>	 <p>Schwarz P 3217-S L = x</p>	 <p>Edelstahl matt mit Fräsung für Fingerscan dLine 310 053 L=1000 mm 310 054 L=1300 mm 310 055 L=1400 mm 310 056 L=1500 mm 310 057 L=1600 mm</p>	 <p>Edelstahl matt mit LED und zusätzlicher Fräsung für Fingerscan dLine 310 060 L=1000 mm</p>

 <p>Edelstahl matt Mit schräger oder gerader Befestigung TG 50 L=500 mm TG 60 L=600 mm TG 80 L=800 mm TG 100 L=1000 mm TG 120 L=1200 mm</p>	 <p>TG 140 L=1400 mm TG 160 L=1600 mm TG 180 L=1800 mm</p>	 <p>Edelstahl matt Mit schräger Befestigung 316 865 L=400 mm 316 866 L=600 mm 316 867 L=800 mm 316 868 L=1000 mm 316 869 L=1200 mm</p>	 <p>Edelstahl matt Mit gerader Befestigung 316 860 L=400 mm 316 861 L=600 mm 316 862 L=800 mm 316 863 L=1000 mm 316 864 L=1200 mm</p>
--	---	---	--

KRATZERSCHUTZ

 <p>Edelstahl 381 112 60 X 75 mm</p>	 <p>Edelstahl 381 114 55 X 75 mm</p>
---	---



Edelstahl 310 174	Edelstahl 310 179	Edelstahl 310 184	Edelstahl matt 316 668	Edelstahl matt 316 671	Edelstahl matt 316 662	Edelstahl matt 316 665
----------------------	----------------------	----------------------	---------------------------	---------------------------	---------------------------	---------------------------

FARBGESTALTUNGEN

Vielfältige Farbgestaltungen für die Alu-Oberflächen
Auszug

MASTER COLLECTION feinstruktur, metallic



Iceberg Blue
Feinstruktur Metallic



Rumbling Sky
Feinstruktur Metallic



Night Grey
Feinstruktur Metallic



Cast Iron
Feinstruktur Metallic



Russet Copper
Feinstruktur Metallic



Brown
Feinstruktur Metallic

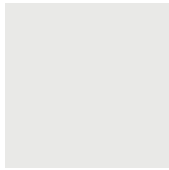

Arctic Ice
Feinstruktur Metallic



Precious Sand
Feinstruktur Metallic



Verdigris
Feinstruktur Metallic



Granit Nature
Feinstruktur Metallic



Volcanic Ash
Feinstruktur Metallic



Elves Bench
Feinstruktur Metallic

ANODIZING COLLECTION matt, metallic



ORIGINAL PLATINIUM
Matt Metallic



SILVER DREAM
Matt Metallic

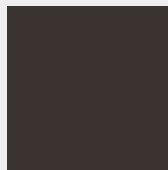

CARBON NIGHT
Matt Metallic



DARK COPPER
Matt Metallic



SIMPLY COPPER
Matt Metallic



GREY BD
Matt Metallic

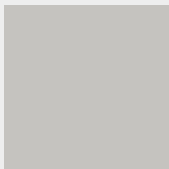

GSPED 0
Matt



GSPED 1
Matt

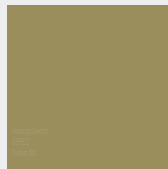

GSPED 2
Matt



GSPED 3
Matt

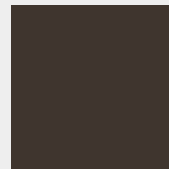

GSPED 4
Matt



NOBLE BRONZE
Matt Metallic

RAL FARBEN matt, feinstruktur, metallic, glatt

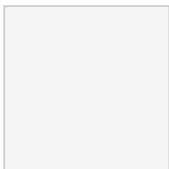

RAL 9016
Feinstruktur



RAL 7040
Feinstruktur

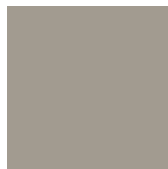

RAL 7039
Feinstruktur



RAL 7012
Feinstruktur



RAL 7015
Feinstruktur



RAL 7016
Feinstruktur

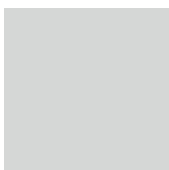

RAL 9006
Metallic glatt



RAL 9007
Metallic Feinstruktur



DB 703
Metallic Feinstruktur



RAL 7021
Feinstruktur



RAL 9005
Feinstruktur



RAL 8019
Feinstruktur

STEINDEKOR



Dekor Concrete
Beton optik

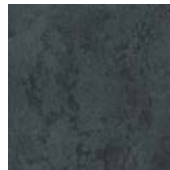

Dekor Beton dunkel

HOLZDEKOR



Dekor Altholz
(Stadelholz-1N)

DEKOR PRÄGEDECKLAGE - SERIE TREND AT 100 **New Forest**



Dekor ATTERSEE



Dekor
WOLFGANGSEE



Dekor TRAUNSEE



Dekor MONDSSEE



Dekor ALTAUSSEE

HOLZDEKOR (struktur)

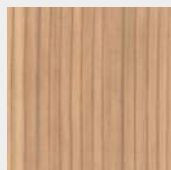

Douglas 6

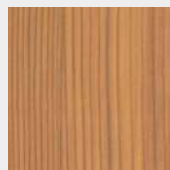

Douglas 7

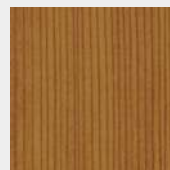

Douglas 2

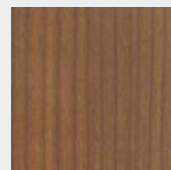

Kirsch 2

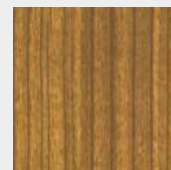

Kirsch 3

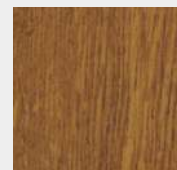

Golden Oak

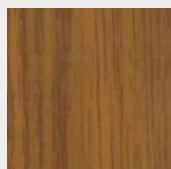

Eiche 2

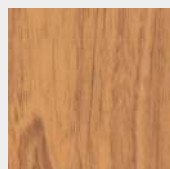

Eiche 4

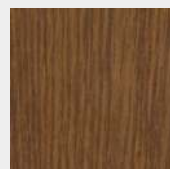

Eiche dunkel

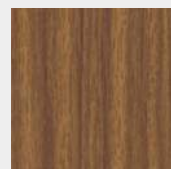

Nuss 1

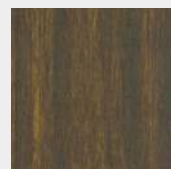

Walnuss dunkel

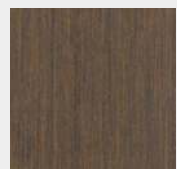

Wenge

HOLZDEKOR - Serie REFINED

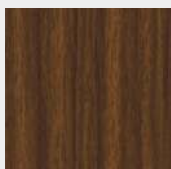

Nussbaum FS

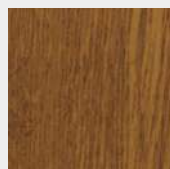

Golden Eiche FS

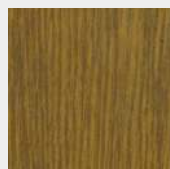

Helle Eiche



Dunkel Eiche

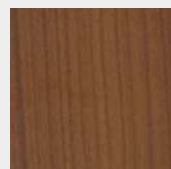

Kirsche

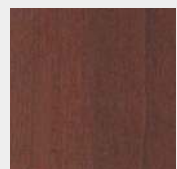

Mahagoni

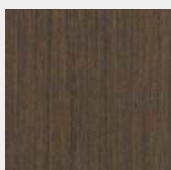

Wenge

ORNAMENTGLÄSER



Kathedral Klein. weiss



Chinchilla weiss

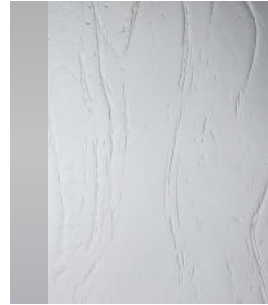

Gothic weiss

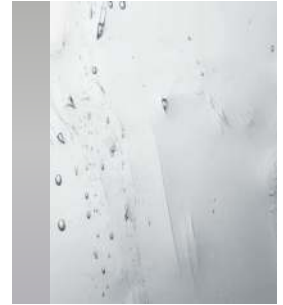

Altdeutsch K weiss

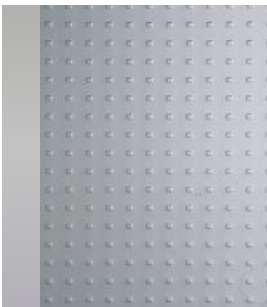

Mastercarre weiss



Masterligne weiss

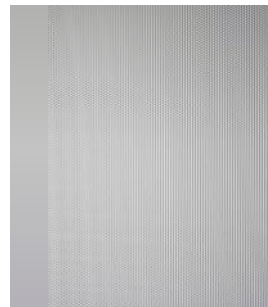

Masterpoint weiss

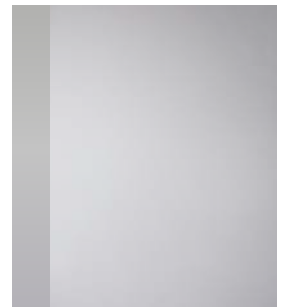

Satinato weiss

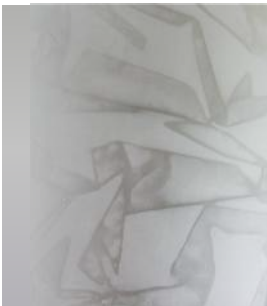

Silk weiss

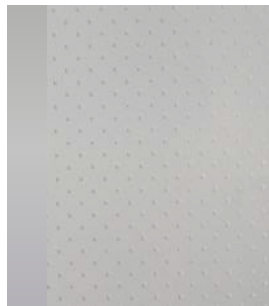

Pave weiss

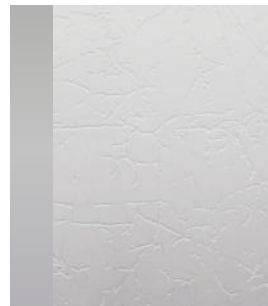

Uadi weiss

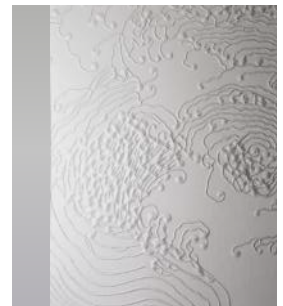

Nebulosa weiss

WÄRMESCHUTZGLAS

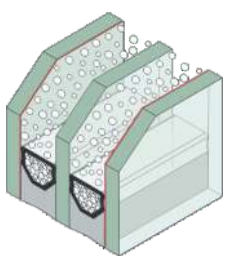

dreifach

SANDGESTRAHLTE MOTIVE

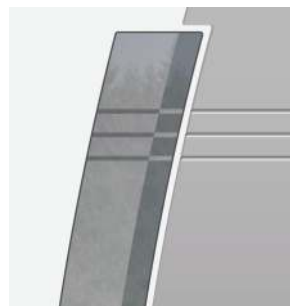

REFINED
AR



Triumph - Seite 7



Canary/ AST 100A - Seite 6



Levent - Seite 7

TREND
New Forest
AT



AT 100 **NF** Attersee



AT 100 **NF** Wolfgangsee
- Seite 8



AT 100 **NF** Mondsee
- Seite 9



AT 100 **NF** Traunsee
- Seite 9



AT 100/ AST 100A **NF** Altausee
- Seite 9

TREND
AT



AT 100A/ AST 100A - Seite 21



AT 101 - Seite 21



AT 102 - Seite 21



AT 100 - Seite 11



AT 121 - Seite 15



AT 131 - Seite 12



AT 153A - Seite 31



AT 255 - Seite 31



AT 264 - Seite 17

ABGEBILDETE TÜREN IN DER ÜBERSICHT



AT 264A/AST 100A - Seite 13



AT 265/AST 100A - Seite 12



AT 265A - Seite 17



AT 266 - Seite 13



AT 266A - Seite 13



AT 267 - Seite 29



AT 801B - Seite 18



AT 810/AST 100A - Seite 15



AT 843/AST 100A - Seite 29



AT 862A/AST 100A - Seite 18



AT 863A/AST 100A - Seite 26



AT 863B - Seite 26



AT 863C - Seite 27



AT 864/AST 100A - Seite 28



AT 867 - Seite 20



AT 875A - Seite 29



AT 883/AST 100A - Seite 31



AT 887 - Seite 30



AT 887B - Seite 30



AT 891A - Seite 20



AT 894 - Seite 11



AT 904 - Seite 28



AT 906 - Seite 19



AT 906A - Seite 19



AT 907 - Seite 15



AT 909/AST 100A - Seite 14



AT 919 - Seite 14



AT 924A/AST 100A - Seite 23



AT 934 - Seite 25



AT 941A/AST 100A - Seite 19



AT 943 - Seite 27



AT 944 - Seite 22



AT 945A - Seite 22



AT 946A - Seite 23



AT 946B - Seite 23



AT 947/AST 100A - Seite 27



AT 948/AST 100A - Seite 25

DELUXE
AD



AD 801A - Seite 35



AD 801A/AST 100A - Seite 35



AD 801B - Seite 33



AD 843A - Seite 33

ABGEBILDETE TÜREN IN DER ÜBERSICHT



AD 863D - Seite 35



AD 945/ AST100A - Seite 34



AD 945 - Seite 34

MODERN
AM



AM 132A - Seite 38



AM 132A - Seite 38



AM 131 - Seite 39



AM 134B - Seite 37



AM 156 - Seite 37



AM 170 - Seite 39



AM 170/ AST 100A - Seite 39

CLASSIC
AC



AC 182A - Seite 42



AC 183 - Seite 43



AC 183 - Seite 43



AC 185/ AST 185 - Seite 43



AC 190A/ AST 190 - Seite 45



AC 191/ AST 191 - Seite 44



AC 194A - Seite 44



AC 195A - Seite 42



AC 203A - Seite 41



AC 207- Seite 41



AC 209A - Seite 45



AC 209 - Seite 45

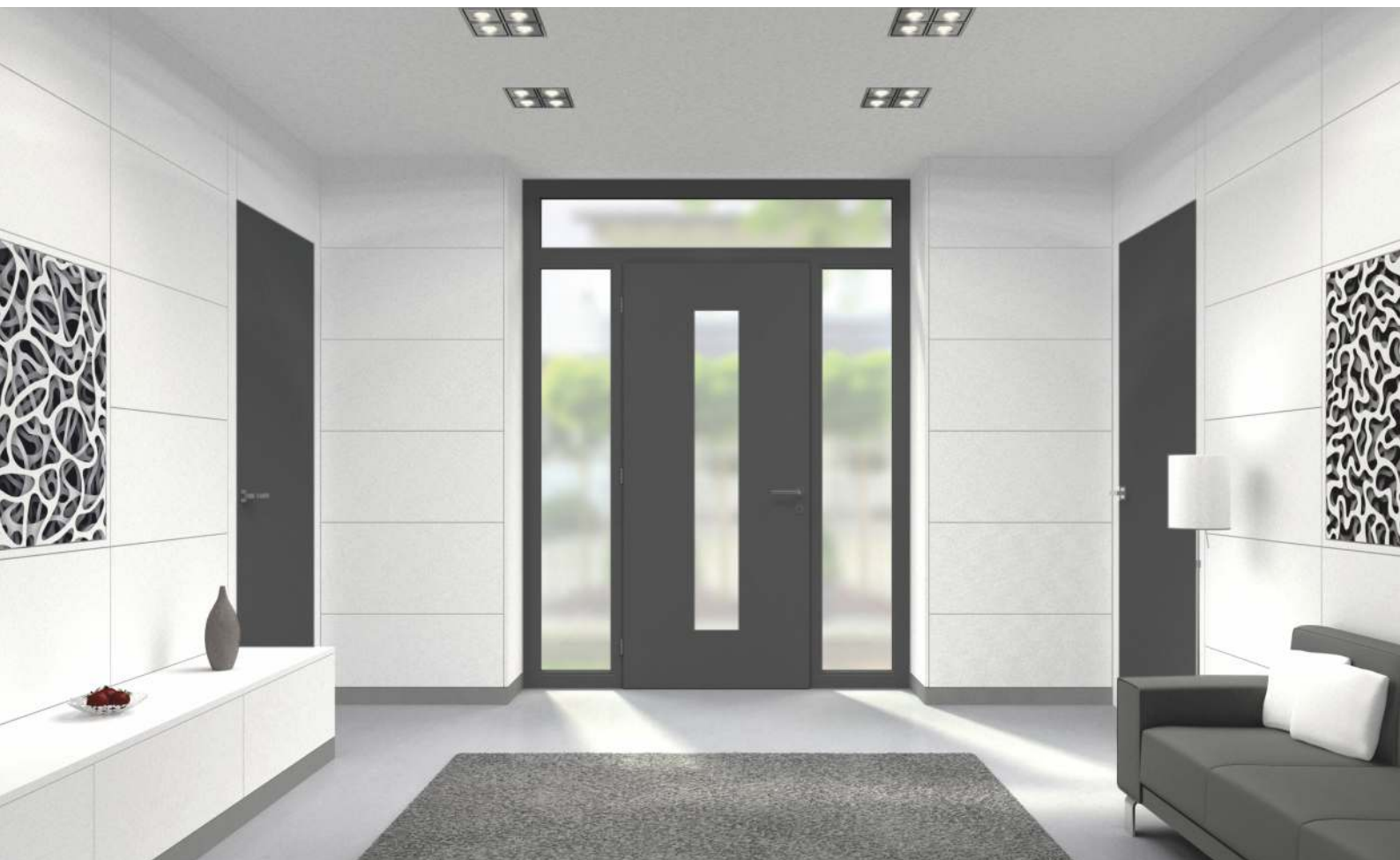

Aufgrund drucktechnischer Gegebenheiten können Farbabweichungen zwischen den Darstellungen in diesem Prospekt und den Original-Produkten auftreten.

www.isarholz.com



Wir freuen uns, Sie persönlich zu beraten.