



LESENA IN LES/ALUMINIJ VHDNA VRATA

LES IN LESENI PROFILI

- ☐ Uporabljen les ustreza kakovostnim zahtevam standarda EN 942.
- ☐ Vlažnost lesa je kontrolirana in znaša 13 ± 2 %.
- ☐ Les je skladiščen v prostorih z regulirano zračno vlažnostjo, kar preprečuje pokanje in ostale napake povezane z neustrezno vlažnostjo lesa.
- ☐ Leseni profili okvirja debeline 68, 80 mm ter različne debeline kril.
- ☐ Profili so zlepjeni iz treh slojev z vodoodpornim lepilom skupine D4 po EN 204 in pr EN 14257.
- ☐ V pokončnih krila programa CLASSIC so vgrajeni aluminijasti ali jeklenimi stabilizatorji za preprečevanje zvijanja krila.



VRATNA KRILA

- ☐ Debelina standardnih vratnih kril je 68 mm in 80 mm. Opcija nizkoenergijsko krilo debeline 95 mm in PASIVNO krilo debeline 98 mm.
- ☐ Površina kril je obložena s furnirano vezano ploščo za lazurne premaze ali mdf ploščo za prekrivne barve. Vgrajena je ojačitev iz aluminija ali jekla za večjo stabilnost krila.
- ☐ Sredica iz trde toplotno izolativne PUR pene. Na obeh straneh krila je vgrajena parna zapora iz aluminija.

OKOVJE

- ☐ Kakovostna tridimenzionalno nastavljiva standardna nasadila Baka Protect 4010 3D FD (HH68) in skrita nasadila Tectus TE 540 3D (HH80).
- ☐ 3 ali 5-kratna zapora krila.
- ☐ Različne opcije odpiranja; odpiranje navzven, odpiranje na prstni odtis, električno odpiranje, ...

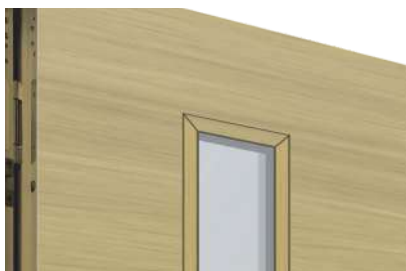

ZASTEKLITEV

- ☐ Na izbiro imamo široko paleto toplotno in zvočno izolativnih ter varnostnih stekel.
- ☐ Velika izbira ornamentev in vitražev tudi po vaših željah.
- ☐ Dodelava stekla z različnimi folijami, steklenimi dodatki, peskanjem, ...

POVRŠINSKA OBDELAVA

- ☐ S široko paleto premazov za les smo prepričani, da boste lahko našli barvo po svojem okusu.
- ☐ Obloge iz aluminija so prašno lakirane, kar je ekološko prijaznejše in zagotavlja odlično kakovost ter obstojnost obarvane površine.



ODPIRANJA

Odpiranje navznoter, pogled od zunaj



LEVO ODPIRANJE



DESNO ODPIRANJE

TIPI Odpiranje navznoter, pogled od znotraj

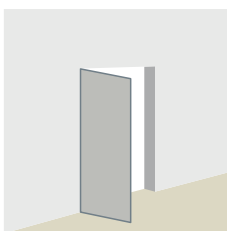

Tip 01

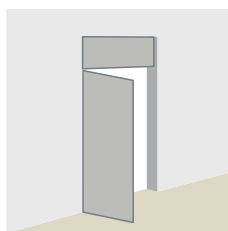

Tip 02

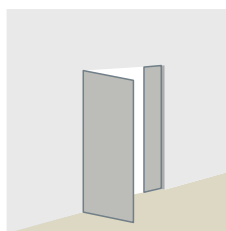

Tip 04

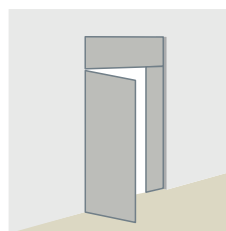

Tip 05

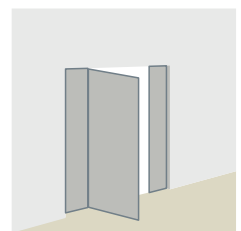

Tip 07

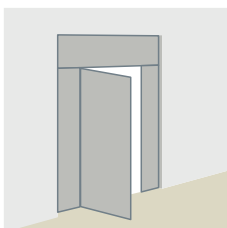

Tip 08

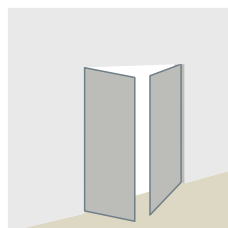

Tip 21

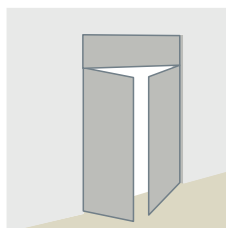

Tip 22

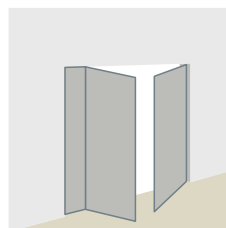

Tip 24

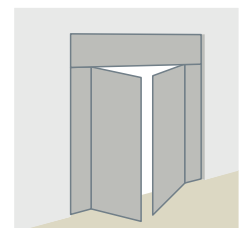

Tip 25

Lesena vrata **zunaj**

model HTR 106B, deb. 68/ 95 mm
 poravnana
 les in barva: krilo hrast RE 200
 okvir Ral 7016



Holz/Alu Fenster **zunaj**

INO-HA80-MM poravnana
 INO-HA80-ML poravnana
 INO-HA80-F poravnana
 barva aluminija: RAL 7016 Fs



Leseno okno **zunaj**

INO-92, INO-80
 les in barva: hrast RE 200

ROKOVANJE



Odpiranje vrat na prstni odtis s čitalcem dLine



Prijemalo z integriranim čitalcem prstnih odtisov dLine



Odpiranje vrat na prstni odtis s čitalcem Idencom



Odpiranje vrat s tipkovnico

Lesena vrata **notranja stran**

Model HTR 106B, deb. 68/95 mm
Les in barva: hrast RE 200

Les/aluminij okno **notranja stran**

INO-HA80-MM *poravnana*
INO-HA80-ML *poravnana*
INO-HA80-F
les in barva: hrast RE 200



Leseno okno **znotraj**

INO-92, INO-80
les in barva: hrast RE 200



LED LUČI



Prijemalo z integrirano
LED osvetlitvijo



LED-Diode

KUKALA

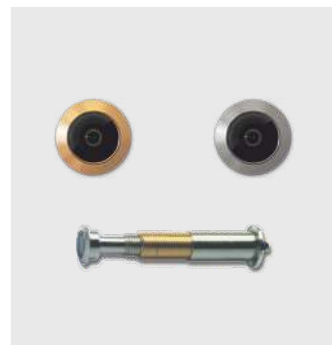

LES/ALUMINIJ VHDNA VRATA INO-HAH

z aluminijasto oblogo

les deb. 80 mm

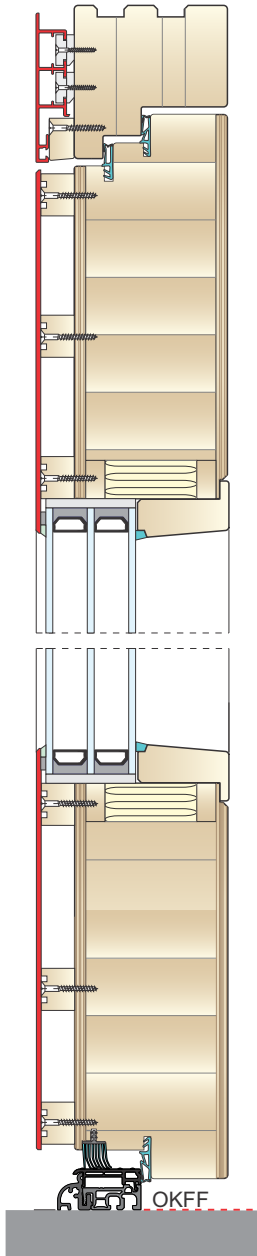

Serijska **TREND ALPHA**

z aluminijasto oblogo

les deb. 68 mm

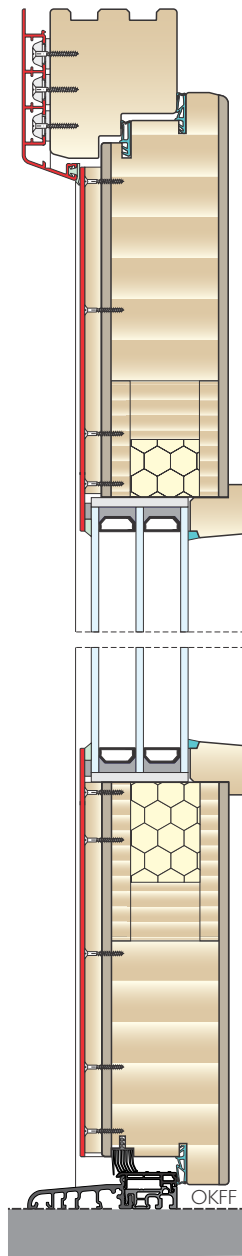

Serijska **TREND MODERN**

z aluminijasto oblogo

les deb. 68 mm

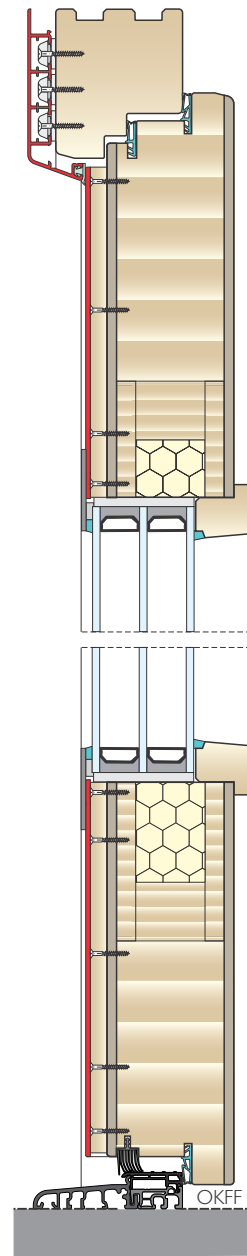

Serijska **DELUXE**

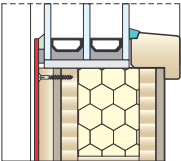
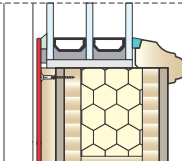
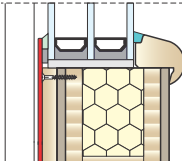
LES DEB. 68 mm	<p>STANDARDNO OGLATA zasteklitvena letvica</p> 	<p>OPCIJA PROFILIRANA zasteklitvena letvica</p> 	<p>OPCIJA ZAobljena zasteklitvena letvica</p> 
----------------	---	--	--

LESENA VHODNA VRATA INO-HH

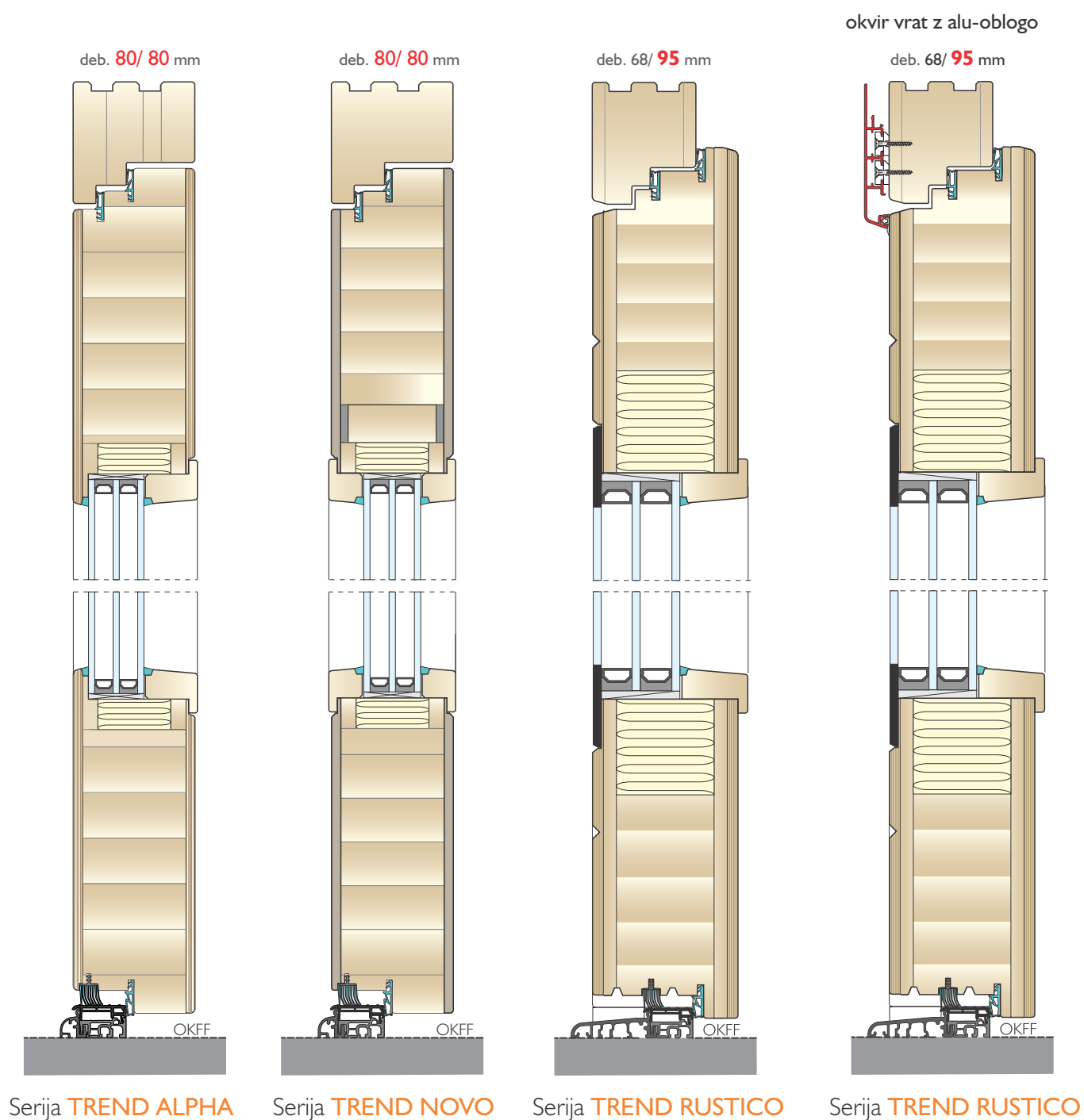

LESENA VHODNA VRATA **INO-HH**

deb. 68/ 68-95 mm

deb. 68/ 68 mm

deb. 68/ 68 mm

deb. 68/ 68 mm

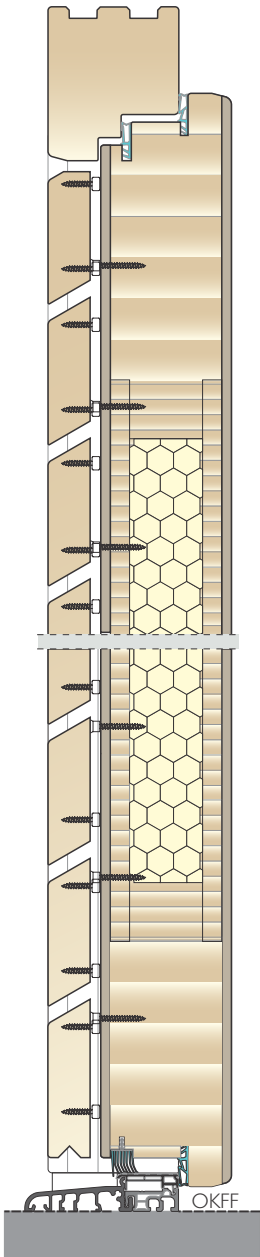

Seriya **TREND LINE**

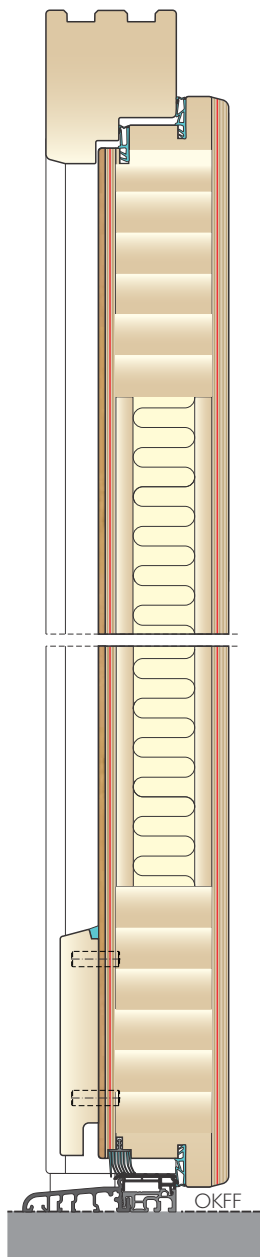

Seriya **TREND HBF**

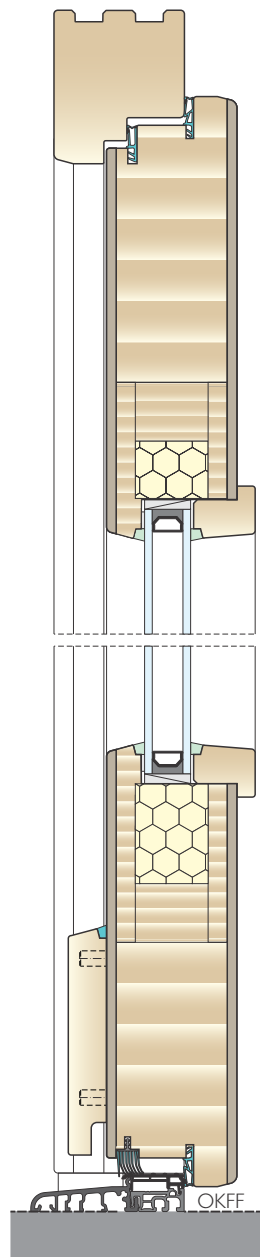

Seriya **TREND**

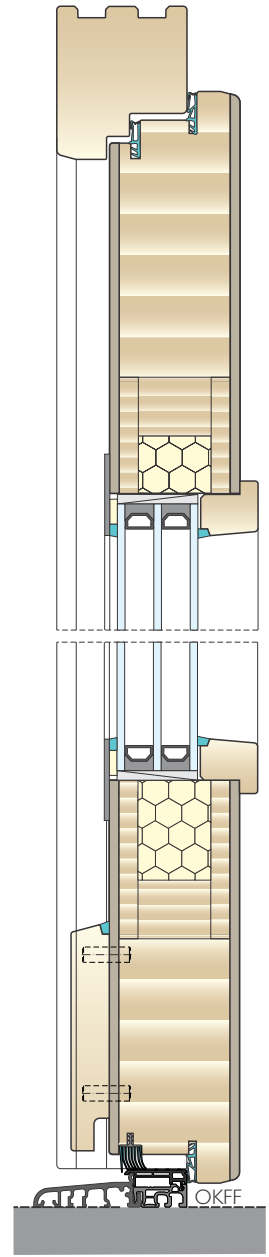

Seriya **DELUXE**

LESENA VHODNA VRATA INO-HH

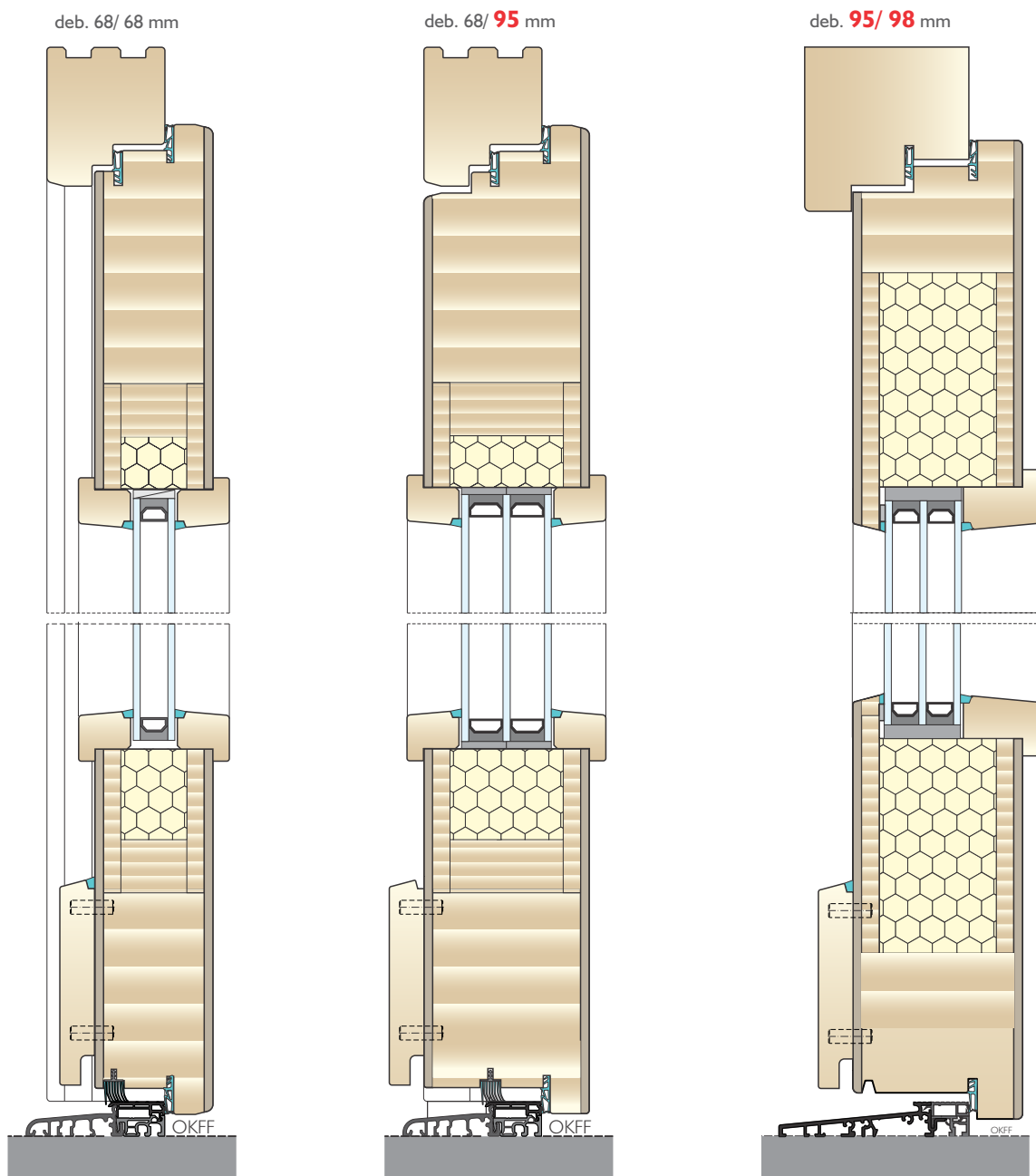
Serija **MODERN**Model **TREND, HT 100**
Serija **MODERN**

NIZKO
ENERGIJSKO

Model **TREND, HT 264**

PASIVNO

LES/ALUMINIJ VHODNA
VRATA **INO-HAH**

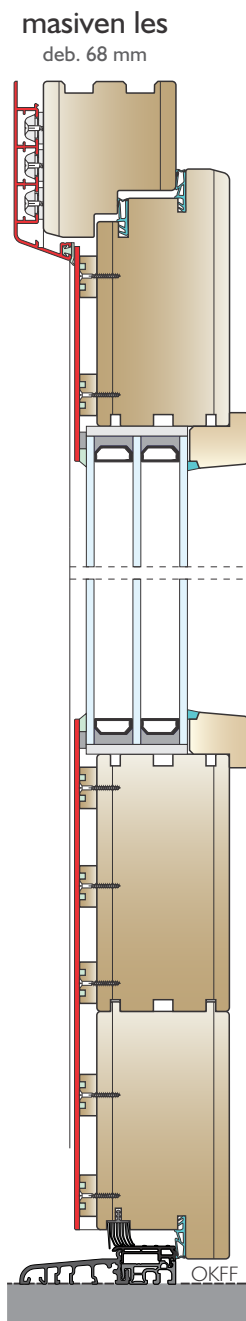

Seriya **KLASSICO**
(zaradi tehničnih razlogov
vsi modeli niso na voljo.)

LESENA VHODNA
VRATA **INO-HH**

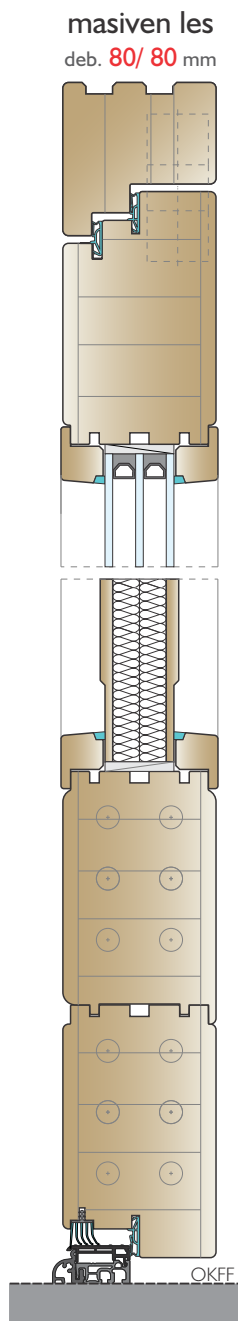

Seriya **KLASSICO ETA**

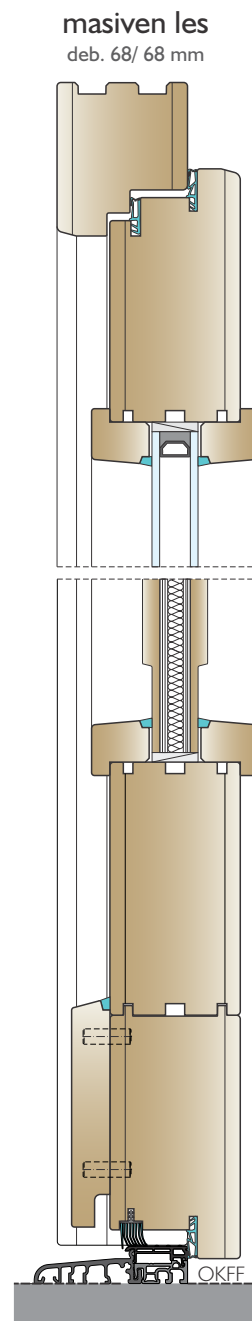

Seriya **ANTICO,
RUSTICO, KLASSICO,
NEOKLASSICO**

LESENA VHODNA VRATA **INO-HH**

STANDARDNO **HH 68**
OGLATO (zastk. letvica in odkapna letev)
BKV 80 TB pohodni prag

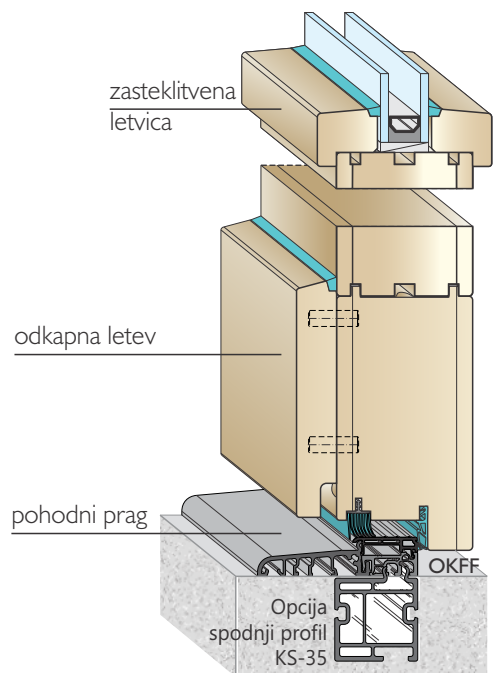

STANDARDNO **HH 80**
BKV 40 TB pohodni prag

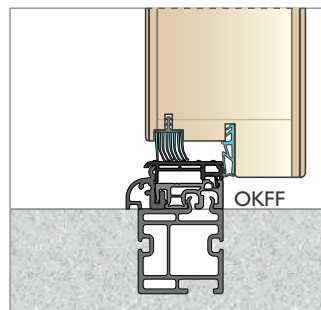

OPCIJA **HH 80**
BKV 80 TB pohodni prag

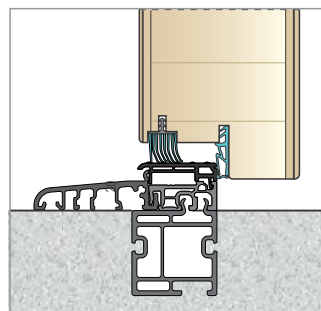

OPCIJA
PROFILIRANO (zastekl. letvica,
odkapna letev)
AV-02 pohodni prag

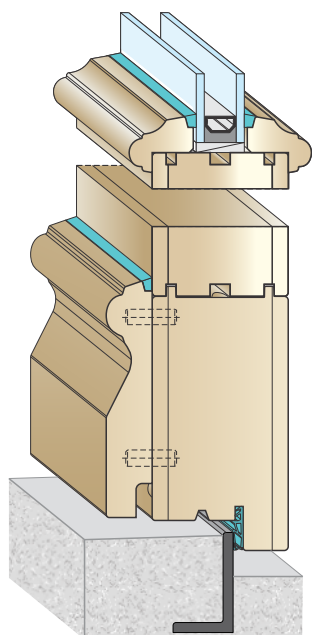

OPCIJA
ZAobljeno (zastekl. letvica,
odkapna letev)
AV-07 pohodni prag

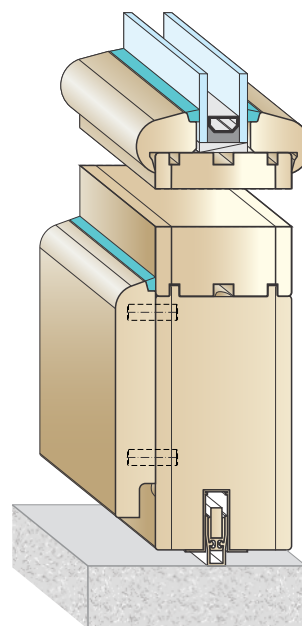



Visoka stopnja varnosti

Poleg visokega standarda kakovosti lesenih in les/aluminij vhodnih vrat, so ta opremljena s 3-točkovnim zaklepanjem kot standardnim zaklepanjem.

Vrata lahko z vidika varnosti nadgradite z certificirano stopnjo varnosti RC2 in jih opremito z elementi za enostavnejšo in bolj praktično uporabo.

1 VARNOSTNI ZATIČI



2 VARNOSTNO STEKLO P4A



3 ENODELNA PRIPIRINA LETEV



4 VARNOSTNI CILINDER Z ZAŠČITO PROTI PREVRTANJU

5 VARNOSTNA GARNITURA



3 NASADILA



BAKA PROTECT 4010 3D FD
- BAND HH 68
trodimenzionalno nastavljiva



TETCUS TE 540 3D
- SKRITA NASADILA HH 80
trodimenzionalno nastavljiva

4 POHODNI PRAGI



BKV 80 TB
HH 68



BKV 40 TB
HH 80

STV-1 (standardno)
3-kratna zapora
2 kavlja

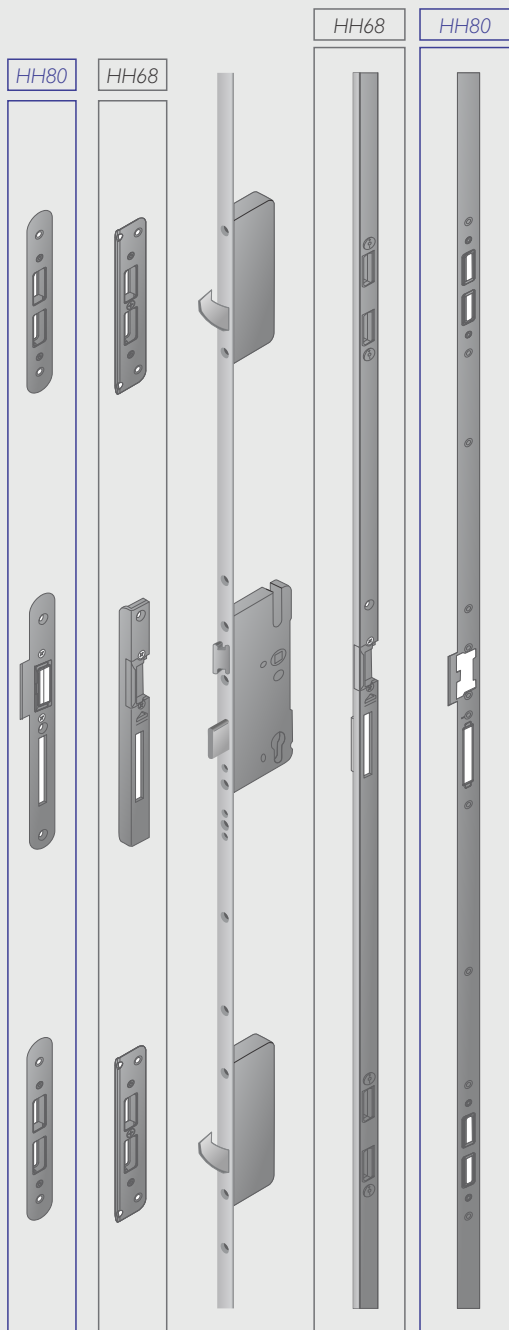

STV-1K
MEHANSKA ZAPORA
s komfort funkcijo
5-kratna zapora

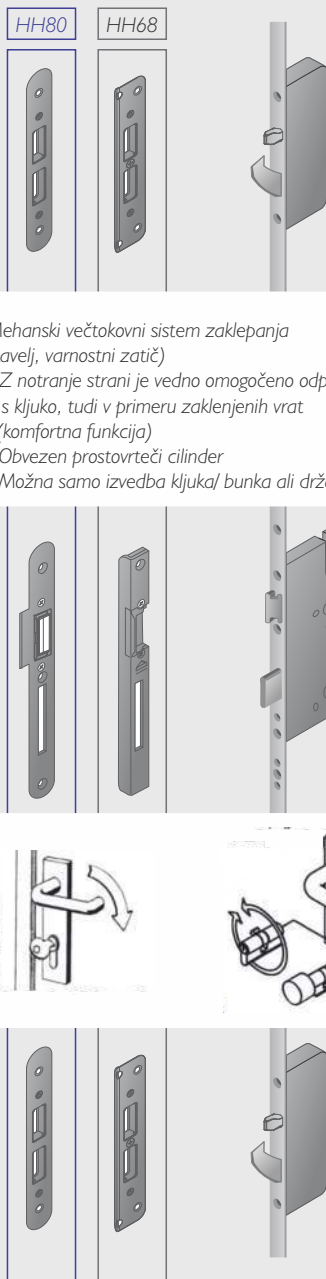

Mehanski večtokovni sistem zaklepanja (kavelj, varnostni zatič)
 - Z notranje strani je vedno omogočeno odpiranje s kljuko, tudi v primeru zaklenjenih vrat (komfortna funkcija)
 - Obvezen prostovrteči cilindar
 - Možna samo izvedba kljuka/ bunka ali držalo/ kljuka

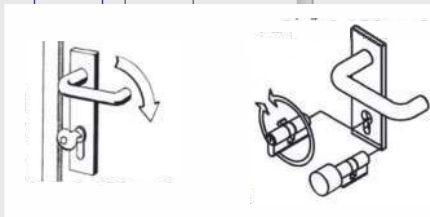

STV-2
5-kratna zapora
4 kavlji

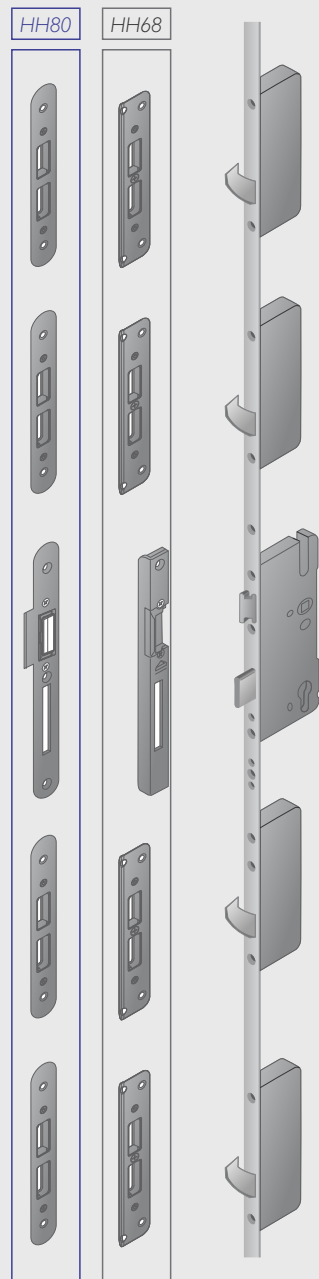

CILINDRIČNI VLOŽKI

KI STANDARD - cilindrični vložek (N+G) z dvostranskim varnostnim delovanjem in s 6 ključi (standardno)



KISK - cilindrični vložek z gumbom na notranji strani in s 6 ključi

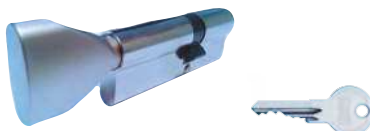

K5 - varnostni cilindrični vložek (N+G) z zaščito proti prevrtanju in s 6 ključi



STV-4

3-kratna zapora
2 avtomatska varnostna zatiča

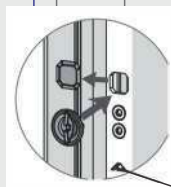
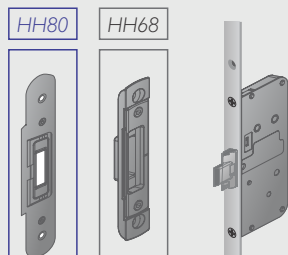

Tandeo
dnevno/nočni režim

STV-4 je mehansko-avtomatski večtočkovni sistem zapiranja, pri katerem se zapirni elementi samodejno pomaknejo v zaprti položaj, tako, ko se vrata zaprejo. Zahvaljujoč varnosti s certifikatom VdS je ključavnica že zaklenjena brez uporabe ključa. Samodejni sistem zaklepanja je mogoče vklopiti ali izklopiti z naknadno vgradljivim stikalom dan/noč.

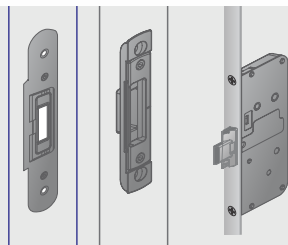

STV-4-M

(E600-Eneo A)
3-kratna zapora
2 avtomatska varnostna zatiča
z motorno funkcijo
vklj. napajanje

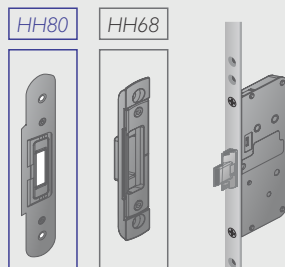

Eneo A je elektromehanski sistem večkratnega zaklepanja, pri katerem se prednosti mehansko-avtomatskega zaklepanja dopolnjujejo s priročnostjo motornega odklepanja in sistemov za nadzor dostopa. Opcijsko je mogoče v motor vgraditi daljinski sprejemnik. Z uporabo ključavnice E600 • Eneo A se vrata zaklenejo mehansko in avtomatsko, kar pomeni, da se dodatne ključavnice samodejno pomaknejo ven, takoj ko vrata padejo v ključavnico. Če brez uporabe ključa velja ključavnica zahvaljujoč VdS certificirani varnosti kot zaklenjena.

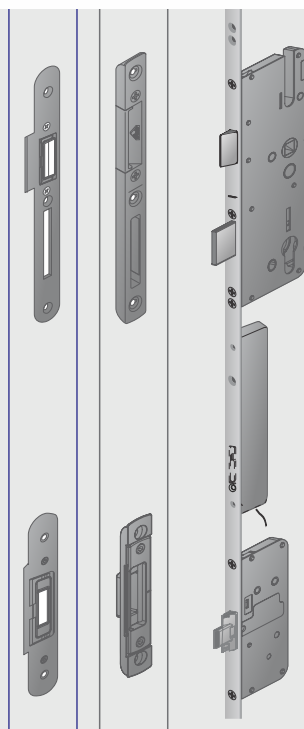

E610-Eneo 2C
5-kratna zapora
vklj. napajanje

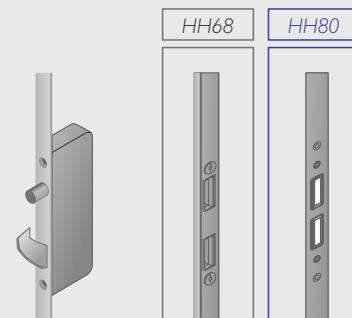

E610 - Eneo 2C je elektromehanski sistem večkratnega zaklepanja, pri katerem se glavna ključavnica in dodatne ključavnice odpirajo in zaklepajo z motorjem. Zahvaljujoč udobnemu odpiranju lahko vhodna vrata vedno odprete od znotraj s pomočjo kljuke, tudi ko so zaklenjena. Hišo lahko vedno varno zapustite, avtomatsko zaklepanje pa nudi zaščito pred vlomom in krajo. Daljinski sprejemnik je serijsko vgrajen v pogonsko enoto. Samodejni sistem zaklepanja je mogoče vklopiti ali izklopiti z naknadno vgradljivim stikalom dan/noč.

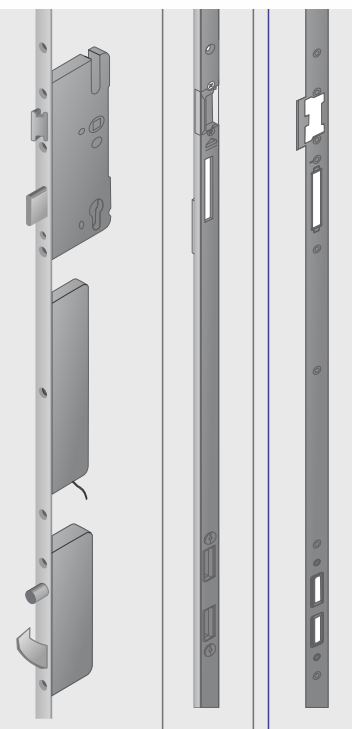

Biometrični način vstopa s prstnim odtisom

Elegantna rešitev, čitalec se lahko vgradi neposredno v vratno krilo ali vratno prijemalo.



Lesena vhodna vrata **zunanja stran**

Model HT 862A, Serija TREND
 Les in barva: krilo macesen RL 200
 Okvir Ral 7037

HIŠNA ŠTEVILKA KOT
 MOTIV NA STEKLU



ZUNANJE ROZETE

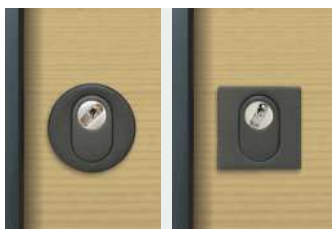

V ČRNI BARVI

PISEMSKI NABIRALNIKI



ODKAPNE LETVE



WSE 03 kot aplikacija iz
 nerjaveče pločevine

Hišna številka iz nerjaveče pločevine



aplikacija iz nerjaveče
 pločevine



WSE 01 iz nerjaveče pločevine



WSE 02 iz nerjaveče pločevine

Lesena vhodna vrata **notranja stran**

Model HT 862A, Serija TREND

Les in barva: macesen RL 200

Vratno zapiralo TS 5000



NOTRANJA PRIJEMALA



NASADILA, GARNITURE KLJUK



Nasadila, notranje kljuke in rozete so barvno skladne.

PRIJEMALA

<p>nerjaveča pločevina mat</p> <p>P 3202 L=350 mm P 3214 L=1500 mm</p> <p>P 3204 L=550 mm P 3216 L=1800 mm</p> <p>P 3206 L=750 mm P 3218 L=2000 mm</p> <p>P 3208 L=950 mm P 3217 L=X mm</p> <p>P 3210 L=1150 mm</p> <p>P 3212 L=1350 mm</p> <p>Schwarz</p> <p>P 3217 L = x</p>	<p>nerjaveča pločevina mat</p> <p>Mit schräger Befestigung</p> <p>316 865 L=400 mm</p> <p>316 866 L=600 mm</p> <p>316 867 L=800 mm</p> <p>316 868 L=1000 mm</p> <p>316 869 L=1200 mm</p> <p>Mit gerader Befestigung</p> <p>316 860 L=400 mm</p> <p>316 861 L=600 mm</p> <p>316 862 L=800 mm</p> <p>316 863 L=1000 mm</p> <p>316 864 L=1200 mm</p>	<p>nerjaveča pločevina mat</p> <p>314 585 L=400 mm</p> <p>314 586 L=800 mm</p> <p>314 597 L=1200 mm</p> <p>314 598 L=1600 mm</p> <p>316 847 L=1800 mm</p> <p>314 599 L=2000 mm</p> <p>videz črnega jekla</p> <p>316 870 L=1000 mm</p> <p>316 871 L=1200 mm</p> <p>316 872 L=1400 mm</p> <p>316 848 L=1600 mm</p> <p>316 849 L=1800 mm</p>	<p>nerjaveča pločevina mat/les</p> <p>SG-180 L=1200 mm</p>	<p>Enerjaveča pločevina mat/les</p> <p>SG-124 L=1200 mm</p> <p>s čitalcem prstnih odtisov</p>	<p>SPSG-17 L=1200 mm</p> <p>Z mini kamero</p>
--	---	---	--	---	---

ZUNANJE ROZETE

nerjaveča pločevina



316 205 316 213 316 214

črna



316 878 316 890 316 890

VARNOSTNE ROZETE



319 062 (68) 316 212 316 211
316 207 (80)

ZAŠČITA PROTI PRASKAM

nerjaveča pločevina



381 112 60 X 75 mm 381 114 55 X 75 mm

s čitalcem prstnih odtisov

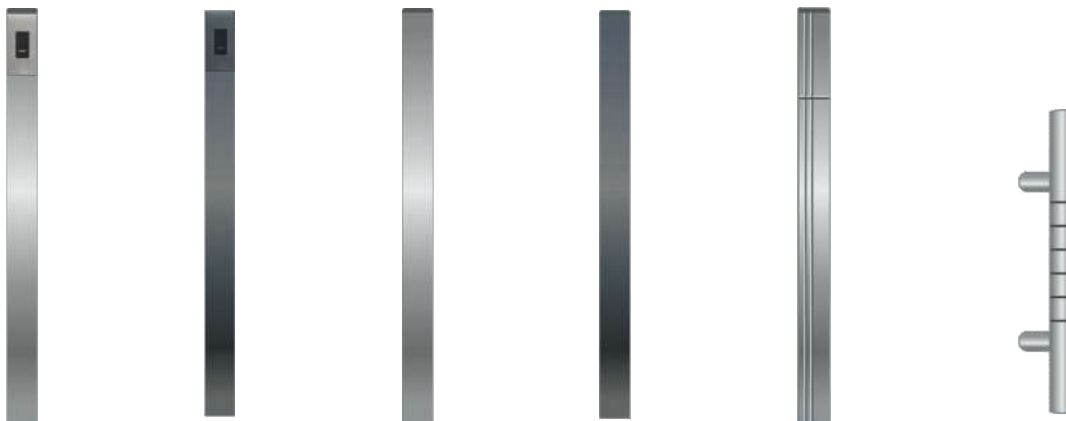

Nerjaveča pločevina mat

P 1182 L=550 mm

črna

P 1182 L=550 mm

Nerjaveča pločevina mat

P 1180 L=550 mm

črna

P 1180 L=550 mm

Nerjaveča pločevina mat

P 1179 L=550 mm

Nerjaveča pločevina

E35303 L=330 mm

E43303 L=400 mm

E63303 L=600 mm

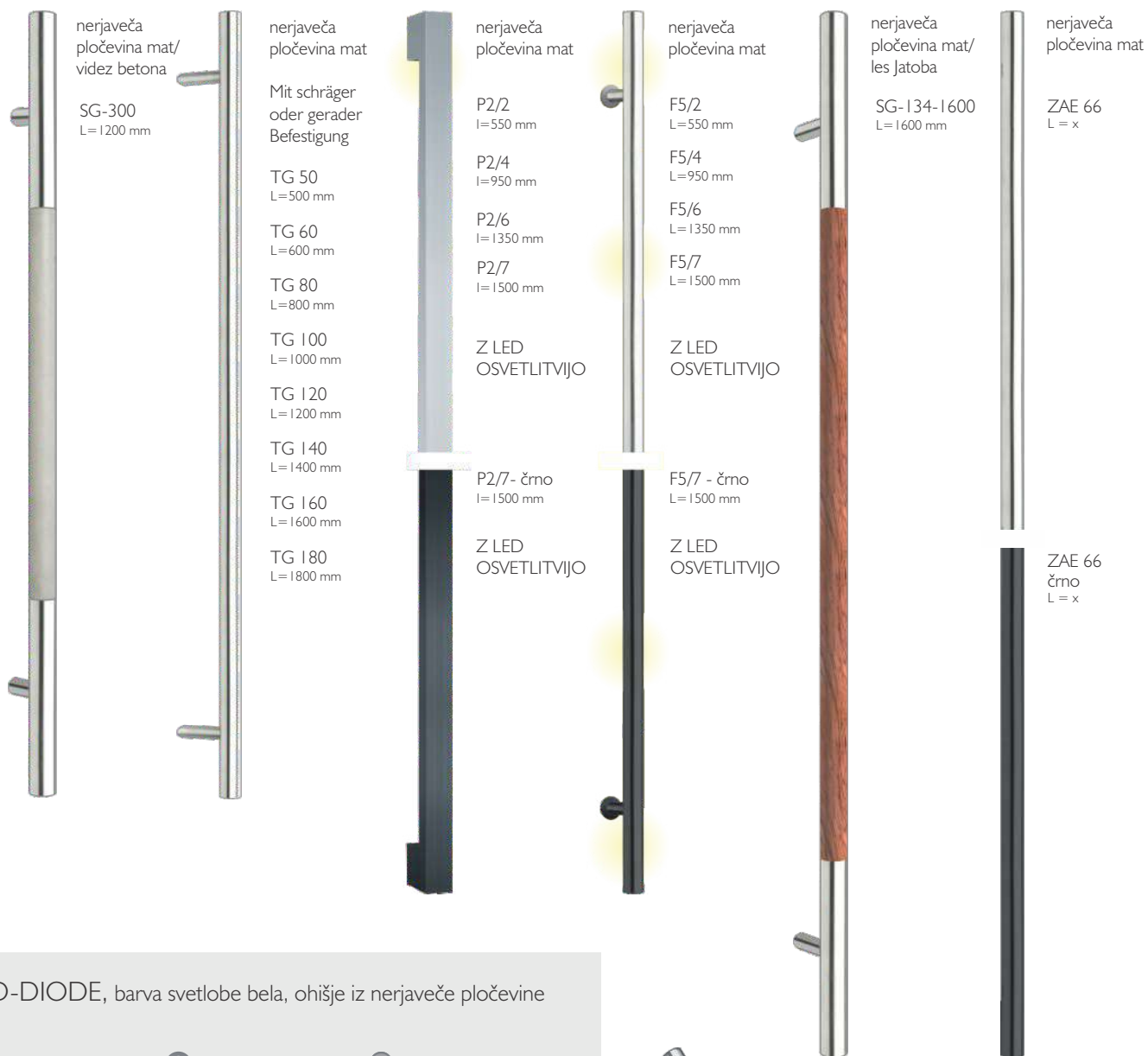

LED-DIODE, barva svetlobe bela, ohišje iz nerjaveče pločevine

L 1 (57 x 57 mm) ○ L 2 (Ø=41 mm) ● L 4 (Ø=35 mm)

L 3 (Ø=60 mm) ○ L 5 (Ø=30 mm)



Medenina polirana
314 543
L=250 mm



brunirana
314 544
L=250 mm



Medenina polirana
284 744
L=330 mm



Nerjaveča pločevina mat
284 487
L=380 mm



Nerjaveča pl. mat
ZAE 66R
L=X mm



Nerjaveča pločevina mat
P 1176
L=380 mm



Nerjaveča pločevina mat
P 1177
L=380 mm

PRIJEMALA



SG-48



SG-79



SG-49



SG-83



SG-77



GS-11



GS-21



GS-20



GS-88



GS-74

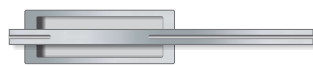

GS-113

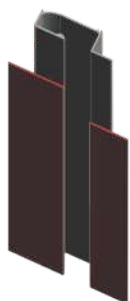

J 137 - ročaj poravnan s krilom

Vtopljen ročaj - v Ral barvi;
Vidna odprtina = 45mm
Dolžina v mm po želji kupca



V 107
L=1400 mm

TRKALA



253 942
medenina - mat krom



253 944
medenina - polirana

NAPISNE PLOŠČICE



NSE I
nerjaveča pločevina



255 506
medenina - polirana



255 510
medenina - polirana

VARNOSTNE GARNITURE



316 254 (L)
316 255 (R)



319 567



314 866



314 839

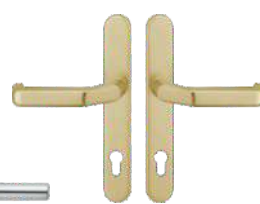

316 242



316 894 (L)
316 895 (R)



316 722

ORNAMENTNA STEKLA

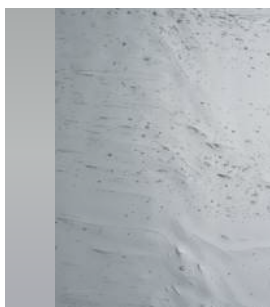

Altd Deutsch belo



Chinchilla belo

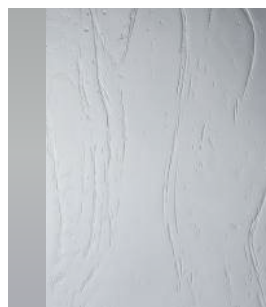

Gothic belo

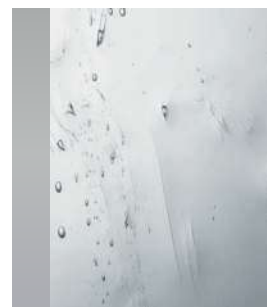

Altd Deutsch K belo

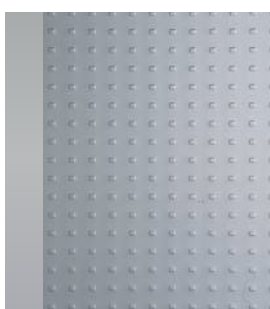

Mastercarre belo



Masterlignè belo

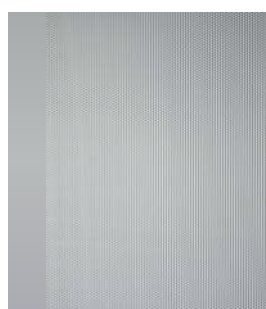

Masterpoint belo



Satinato belo

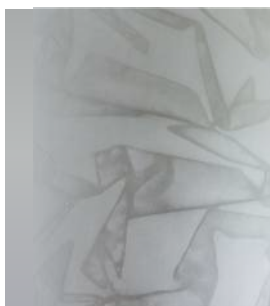

Silk belo

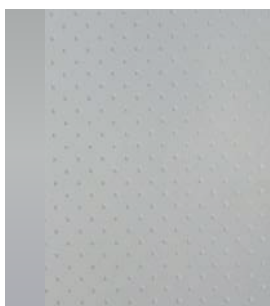

Pave belo

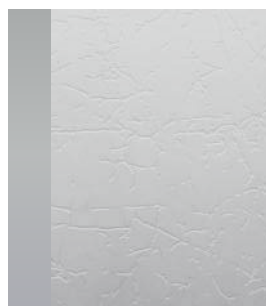

Uadi belo

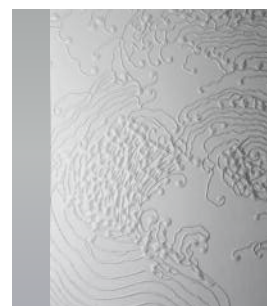

Nebulosa belo

TOPLOTNO IZOLATIVNA
ZASTEKLITEV

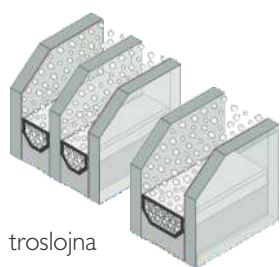

troslojna

dvoslojna

PESKANI MOTIVI



STEKLO Z APLIKACIJO



VITRAŽI



BARVNA KARTA LESENIH POVRŠIN

Za lesena in les/aluminij okna in vhodna vrata

Na razpolago imamo naslednje lesne vrste



smreka



bor



macesen



hrast



meranti

Lazurni premazi (vidna struktura lesa)

Smreka/ bor

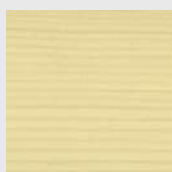

RF 200

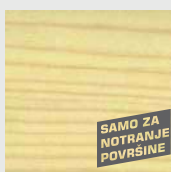

RFI ÖI ▼

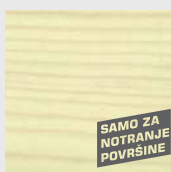

RFI NE



RFI I

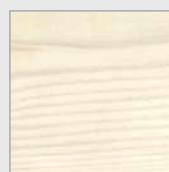

RF/K 10



RFI 10



RF/K 11



RF/K 12

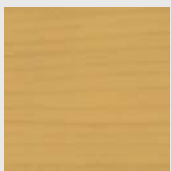

RF/K 19

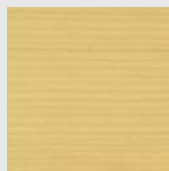

RF/K 21

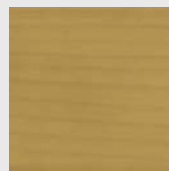

RF/K 22



RF/K 15 *



RF/K 16 *



RF/K 17 *

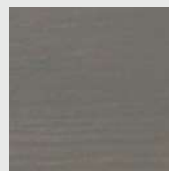

RF/K 26 *

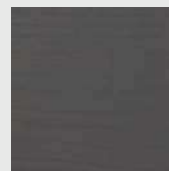

RF/K 27

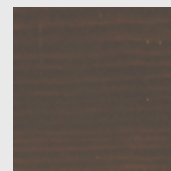

RF/K 25

Bor



RK 1 *



RK 2 *



RK 4 *

Temeljni premaz



R G 1

Macesen



RL 200

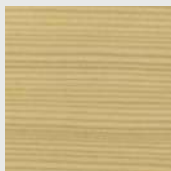

RL ÖI ▼



RLI NE



RLI I



RL 21



RL 22



RL 23

OKOLJU PRIJAZNO

Za naš troslojni sistem površinske obdelave izdelkov uporabljamo okolju prijazne premaze na vodni osnovi.

Za lesena in les/aluminij okna in vhodna vrata

Hrast



ALTHOLZ

NOVO

LESNI DEKOR ALTHOLZ

Možen za dva modela: HT 100, HTA 100

Površinska obdelava: surovo, oljeno ali grundirano

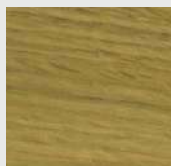

RE 200

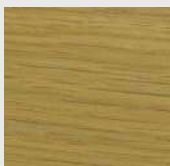

RE Ö1 ▼



REI NE

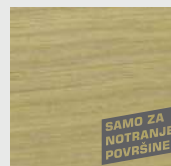

REI I

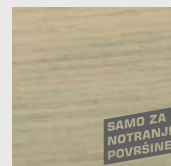

REI 10

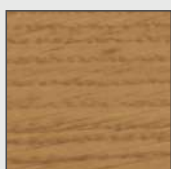

RE 21

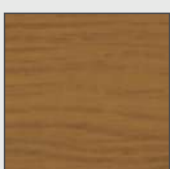

RE 22

Meranti



RM 21



RM 22



RM 23

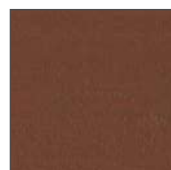

RM 24



RM 25



RM 30



RM 31

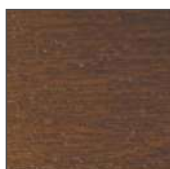

RM 32

POKRIVNE BARVE (ostale pokrivne barve po RAL barvni karti)

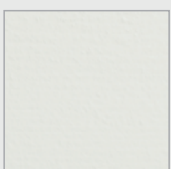

R D 21



R D 22

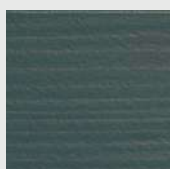

R D 25

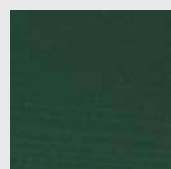

R D 44

Razlaga in opozorilo:

▼ **OLJENO** Na oljeno površinsko obdelavo, Inles ne daje nobene garancije. Take izdelke je potrebno vsaj 2x letno premazati z ustreznim oljem, ki ga lahko kupite pri nas.

✳ **BARVE RF/K 15, RF/K 16, RF/K 17, RF/K 26 in RK 1, RK 2, RK 4**

Ti odtenki močno poudarjajo lesno strukturo in so zato bolj občutljivi na morebitne barvne razlike in različna obarvanja, ki so lahko posledica različnih struktur lesa, vstavljenih smolnic za popravilo žepov s smolo in drugih značilnosti, povezanih s standardnimi tehnološkimi postopki za strojno in površinsko obdelavo lesa. Les je naraven izdelek, zato se po takšni površinski obdelavi z bolj pigmentirano temeljno barvo zaradi različne vpojnosti lesa, kot posledica njegove edinstvene oblike in strukture, ustvari igriva kombinacija barvnih odtenkov. Ker je les naraven proizvod, to ne pomeni, da se zaradi tega njegova kakovost zmanjša ali, da so takšne barvne razlike lahko vzrok za reklamacijo lesenih izdelkov.

BARVE

Ponudba barv za aluminijaste površine
IZBOR

MASTER COLLECTION

(strukturne, metalik)



Night Grey
Feinstruktur Metalik



Cast Iron
Feinstruktur Metalik



Russet Copper
Feinstruktur Metalik



Brown
Feinstruktur Metalik



Verdigris
Feinstruktur Metalik



Granit Nature
Feinstruktur Metalik



Volcanic Ash
Feinstruktur Metalik



Elves Bench
Feinstruktur Metalik

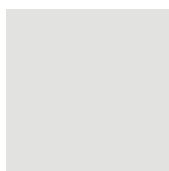

Artic Ice
Feinstruktur Metalik



Precious Sand
Feinstruktur Metalik



Iceberg Blue
Feinstruktur Metalik



Rumbling Sky
Feinstruktur Metalik

ANODIZING COLLECTION

(mat, metalik)

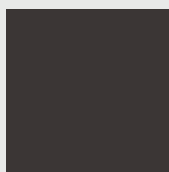

CARBON NIGHT
Matt Metalik



DARK COPPER
Matt Metalik



SIMPLY COPPER
Matt Metalik



GREY BD
Matt Metalik

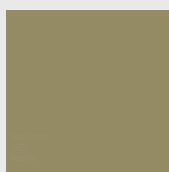

GSPED 2
Matt

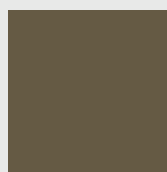

GSPED 3
Matt



GSPED 4
Matt



NOBLE BRONZE
Matt Metalik

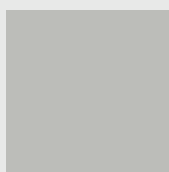

GSPED 0
Matt

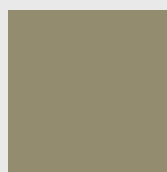

GSPED 1
Matt



ORIGINAL PLATINIUM
Matt Metalik



SILVER DREAM
Matt Metalik

DEKOR - VIDEZ KAMNA **NOVO**

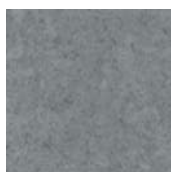

Dekor Zement hell

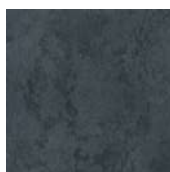

Dekor Beton dunkel

LESNI DEKOR **NOVO**

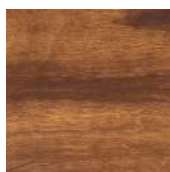

Dekor Altholz



Dekor Stadelholz grau

RAL BARVE

(mat, strukturne, metalik, gladke)

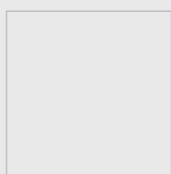

RAL 9016
Matt/ Feinstruktur

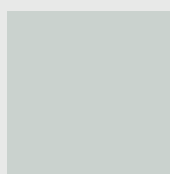

RAL 7035
Matt/ Feinstruktur

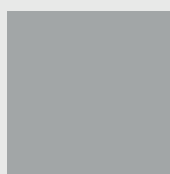

RAL 7004
Matt/ Feinstruktur

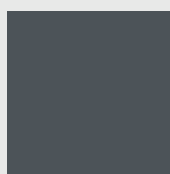

RAL 7016
Matt/ Feinstruktur

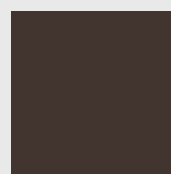

6768 BRAUN
Feinstruktur

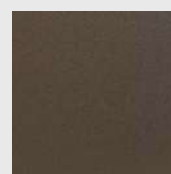

Rostiges eisen
Feinstruktur

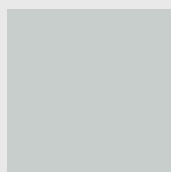

RAL 9006
Metallic glatt



RAL 9007
Metallic glatt



DB 703
Metallic glatt



DB 703
Metallic Feinstruktur

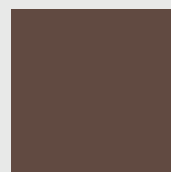

RAL 8017
Matt/ Feinstruktur



RAL 3004
Matt/ Feinstruktur

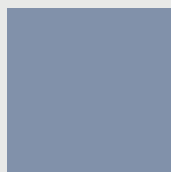

RAL 5014
Matt/ Feinstruktur

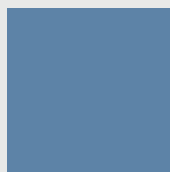

RAL 5007
Matt/ Feinstruktur

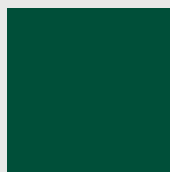

RAL 6005
Matt/ Feinstruktur

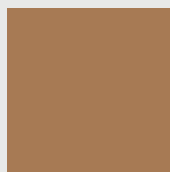

RAL 8001
Matt/ Feinstruktur

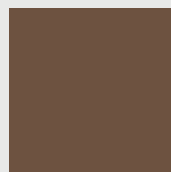

RAL 8003
Matt/ Feinstruktur

Lesni dekorji



Douglas 2



Douglas 6

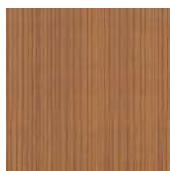

Douglas 7

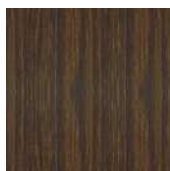

Eiche dunkel

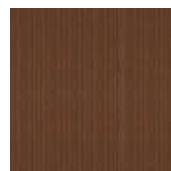

Kirsch 2

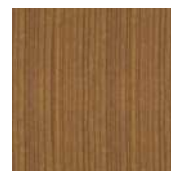

Kirsch 3

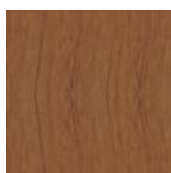

Eiche 4

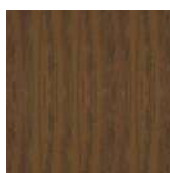

Eiche 2

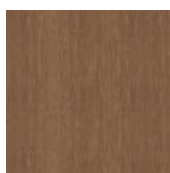

Golden Oak

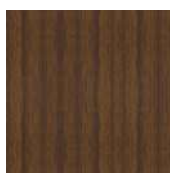

Nuss I

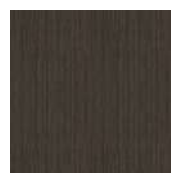

Wenge

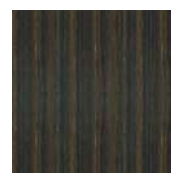

Walnuss dunkel



Inles

Proizvodnja, trženje in inženiring d.d.

SI - 1310 Ribnica, Kolodvorska 22
tel.: 01 8377 100, fax: 01 8377 333
e-mail: info@inles.si

RAZSTAVNO PRODAJNI SALON RIBNICA
tel.: 01 8377 162, 01 8377 308, 01 8377 289

www.inles.si

POOBLAŠČENI PRODAJALEC: