



LESENA IN LES/ALUMINIJ VHDNA VRATA

Individualni poudarki



za polno življenje.

Vhodna vrata so prvi stik obiskovalcev z vašim domom in mnogi pravijo, da so ogledalo našega doma. Vsa Inlesova vhodna vrata so izdelana in oblikovana z izjemnim občutkom za detajle. Ohranjajo toplino v vašem domu in vas varujejo pred nezaželenimi obiskovalci.

V Inlesu smo s širokim izborom različnih modelov vhodnih vrat, dovršenim dizajnom in kakovostno izdelavo poskrbeli, da boste na vaš vhod lahko resnično ponosni.

Lesena vhodna vrata sodobnega ali klasičnega dizajna so z aktualno opremo primerna za vgradnjo v različne objekte.

Vrata so izdelana iz masivnega okvirja in krila sestavljenega iz večslojne masivne plošče z izolativno sredico in masivnim okvirjem.

Vrata odlikuje prefinjena linija motivnih stekel, elegantne aplikacije ter vtopljeni inox trakovi, čarobna igra svetlobe vključenih led svetil in obširna kolekcija dovršenih prijemal.

Prepustite se, uživajte in si izberite ter opremite svoja lastna sanjska vrata.



Živeti z naravo

VSEBINA



Kolekcije lesenih in les/alu vhodnih vrat

TREND ALPHA

8 - 31

Serija vrat TREND Alpha 80 v obojestransko poravnani izvedbi krila in s skritimi nasadili, zagotavlja sodoben in privlačen videz. V kombinaciji z alu aplikacijo ali aplikacijo iz nerjaveče pločevine, ki je poravnana s površino vrat, poveže umetni in naravni material v eno. Široka paleta barv in dodatkov pa vaši kreativnosti pri opremitvi vrat daje proste roke.



TREND

10 - 31

TREND – Domiselno in lahko, drzno in razgibano – vse to in še veliko več boste začutili ob gledanju modelov vhodnih vrat iz serije TREND. Sodobno in aktualno serijo vrat zaznamuje prefinjena linija motivnih stekel, elegantne aplikacije ter vtopljeni inox trakovi, čarobna igra svetlobe vključenih led svetil in obširna kolekcija dovršenih prijemal. Prepustite se, uživajte in si izberite ter opremitve svoja lastna sanjska vrata.



TREND RUSTICO

32 - 35

Površina krila je obojestransko obložena s furnirano, rahlo grčasto vezano ploščo v drevesni vrsti hrast. Na zunanji strani je krilo poravnano z okvirjem.

V kombinaciji s stekleno emajlirano aplikacijo, ali aplikacijo iz nerjaveče pločevine na zunanji strani, poveže tradicionalno z modernim. Široka paleta dodatkov vaši kreativnosti daje proste roke.



TREND LINE

36 - 39

Osnova vrat, okvir in krilo sta na voljo v poljubnih barvah in drevesnih vrstah. Na zunanjo stran krila so iz macesnovega ali hrastovega lesa pritrjene masivne letve, ki poravnane z okvirjem vrat ustvarijo 3D izgled. Površina letev je oljena.

TREND HBF

40 - 43

Moderna vrata z aplikacijo iz furnirane, rahlo grčaste vezane plošče v drevesni vrsti hrast. Kombinacija rustikalnega in modernega ustvari poseben vtis. Široka paleta dodatkov vaši kreativnosti daje proste roke.



DELUXE

44 - 47

Prestižna serija vhodnih vrat DELUXE za tiste, ki hočete nekaj več. Unikaten dizajn skladen z impresivnimi zasteklitvenimi aplikacijami iz aluminija in inoxa, so značilnost te serije. Izbor barvne kombinacije, prijemala, led svetil in ostale opreme za vaša idealna vrata pa prepuščamo vaši domišljiji in lastni kreativnosti.



MODERN

48 - 53

Za lesena in les/aluminij vhodna vrata iz serije MODERN so značilne elegantne linije in preverjene oblike. Zasteklitveni okvirček na zunanji strani vrat poudari estetsko obliko vrat in jih naredi še bolj impulzantne. Vsaka vrata iz serije MODERN lahko opremite s prijemalom in barvo iz inlesove obširne kolekcije ter vanje vključite opremo po svojih željah (led svetila, odpiranje na prstni odtis, hišna številka, varnostna oprema...).



NIZKOENERGIJSKA + PASIVNA

54 - 55

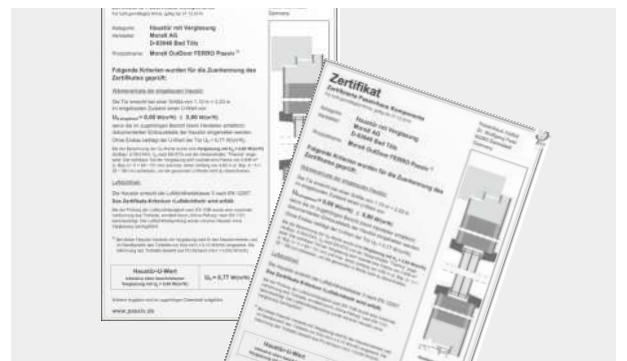

VSEBINA

Kolekcije lesenih vhodnih vrat



TREND NOVO

56 - 59

Lesena vhodna vrata z zasteklitveno letvico na zunanji in notranji strani.

Vrata v obojestransko poravnani izvedbi krila in s skritimi nasadili, zagotavljajo sodoben in privlačen videz.



KLASSICO ETA

60 - 63

Lesena vhodna vrata iz masivnega lesa z zasteklitveno letvico na zunanji in notranji strani.

Vrata v obojestransko poravnani izvedbi krila in skritimi nasadili, zagotavljajo sodoben in privlačen videz.



KLASSICO

64 - 73

Vrata s klasično oblikovano strukturo.



ANTICO

74 - 77

Vrata z najdaljšo tradicijo.

RUSTICO

78 - 85

Vrata oblikovana v želji po nostalgичnem vzdušju.



NEOKLASSICO NEBENEINGANGSTÜREN

86 - 93

Vrata, ki na svojstven način povezujejo tradicijo z individualnostjo.



TEHNIKA

Opis	94
Odpiranje, tipi	95
Udobje/ rokovanje	96
Oblikovanje	97
Sistemi	98 - 103
Varnost, protivlomnost	104
Zapore	105 - 107
Oprema, kljuge	108 - 112
Zastelkitev	113
Barve	114 - 117
Pregled modelov	118 - 127



TREND ALPHA



Seriya vrat TREND Alpha 80 v obojestransko poravnani izvedbi krila in s skritimi nasadili, zagotavlja sodoben in privlačen videz. V kombinaciji z alu aplikacijo ali aplikacijo iz nerjaveče pločevine, ki je poravnana s površino vrat, poveže umetni in naravni material v eno. Široka paleta barv in dodatkov pa vaši kreativnosti pri opremitvi vrat daje proste roke.

80	Ud (Wm ² /K)
H	0,83*

80	Ud (Wm ² /K)
HA	0,83*



HA 80 Les/Alu - vhodna vrata model

HATA 100

Barva aluminija Dekor Zement svetli
Ral 7037
Prijemalo P2/7 - črno
Odpiranje na prstni odtis



HTA 80 Les - vhodna vrata model

HTA 100

Les in barva hrast, RE 200, prečna struktura
Ral 7037
Prijemalo 314 598
Odkapna letev WSE 03

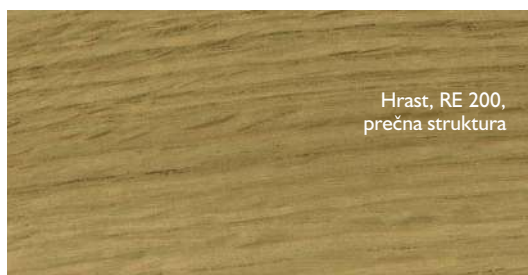

TREND



TREND – Domiselno in lahkotno, drzno in razgibano – vse to in še veliko več boste začutili ob gledanju modelov vhodnih vrat iz serije TREND. Sodobno in aktualno serijo vrat zaznamuje prefinjena linija motivnih stekel, elegantne aplikacije ter vtopljeni inox trakovi, čarobna igra svetlobe vključenih led svetil in obširna kolekcija dovršenih prijemal. Prepustite se, uživajte in si izberite ter opremite svoja lastna sanjska vrata.

68	Ud (Wm ² /K)
H	0,94*

68	Ud (Wm ² /K)
HA	0,94*



HA 68 Les/alu - vhodna vrata model

HAT 100

Barva aluminija Dekor Beton temni
RAL 7024
Prijemalo P 3212

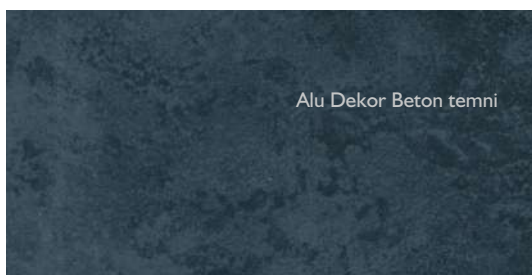

H 68 Les - vhodna vrata model

HT 100

Les in barva Altholz hrast, RG I, prečna struktura,
Ral 9005
Prijemalo P2/7- črno
Odpiranje na prstni odtis





H HA 80

HTA 105

Les in barva macesen, RL 23, prečna struktura, Ral 7016
 Aplikacija emajlirano steklo -RAL 9017
 Prijemalo 316 872 - črno
 Odpiranje na prstni odtis

80	Ud (Wm ² /K)
H	0,83*
HA	0,83*



H HA 80

HTA 103

Barva Ral 7016
 Steklo motiv Satinato belo in emajlirano steklo -RAL 9017
 Prijemalo 316 848 - črno

80	Ud (Wm ² /K)
H	0,85 (Ug 0,6)
H	0,86 (Ug 0,7)
HA	0,84 (Ug 0,5)



H HA 80 68

HTA 123

Les in barva smreka, RF/ 200, prečna struktura,
RAL 7012
Prijemalo P 3214
Odkapna letev WSE 03

	68	Ud (Wm ² /K)	80	Ud (Wm ² /K)
H	0,94*		H	0,83*
HA	0,94*		HA	0,83*



H HA 80 68

HTA 121

Barva Ral 7012
Prijemalo 316 872 - črno

	68	Ud (Wm ² /K)	80	Ud (Wm ² /K)
H	0,94*		H	0,83*
HA	0,94*		HA	0,83*



H HA 80 68

HT 867 / HSTT 400

Barva Ral 7012, Ral 7021
Steklo Ornamentno steklo
Prijemalo ZAE 66 - črno
Odpiranje na prstni odtis

	68	Ud (Wm ² /K)	80	Ud (Wm ² /K)
H	1,0 (Ug 0,7)		H	0,92 (Ug 0,6)
H	1,2 (Ug 1,1)		H	0,96 (Ug 0,7)
HA	0,95 (Ug 0,5)		HA	0,88 (Ug 0,5)



H HA 80 68

HT 264A / HSTT 400

Les in barva hrast, RE Ö1, prečna struktura
Ral 7021
Steklo motiv SM 264A
Prijemalo 316 872 - črno

	68	Ud (Wm ² /K)	80	Ud (Wm ² /K)
H	0,94*		H	0,83*
HA	0,94*		HA	0,83*



H HA 80 68

HTA 264

Barva Ral 7021
Aplikacija nerjaveča pločevina
Prijemalo P 3214
Odkapna letev WSE 03

	68	Ud (Wm ² /K)	80	Ud (Wm ² /K)
H	0,94*		H	0,83*
HA	0,94*		HA	0,83*



H HA 80 68

HTA 874

Barva Ral 9002
 Aplikacija nerjaveča pločevina
 Steklo ornamentno steklo
 Prijemalo SG-300

68	Ud (Wm ² /K)	80	Ud (Wm ² /K)
H	1,0 (Ug 0,7)	H	0,89 (Ug 0,6)
H	1,1 (Ug 1,1)	H	0,92 (Ug 0,7)
HA	0,95 (Ug 0,5)	HA	0,86 (Ug 0,5)



H HA 68

HT 875

Les in barva hrast, RE 22
 Aplikacija nerjaveča pločevina
 Steklo Ornamentno steklo
 Prijemalo 316 866

68	Ud (Wm ² /K)
H	1,0 (Ug 0,7)
H	1,1 (Ug 1,1)
HA	0,95 (Ug 0,5)



H HA 68

HT 864 / HSTT 400

Les in barva hrast, RE Ö1, prečna struktura,
 Aplikacija Ral 7021
 Steklo peskano, SM 864
 Prijemalo P 3217

68	Ud (Wm ² /K)
H	1,0 (Ug 0,7)
H	1,1 (Ug 1,1)
HA	0,99 (Ug 0,5)



H HA 68

HT 911 / HSTT 400

Barva Ral 7039
 Aplikacija Alu HD Wenge, prečna struktura
 nerjaveča pločevina
 Steklo motiv SM 911
 Prijemalo P 3210

68	Ud (Wm ² /K)
H	0,94*
HA	0,94*



H HA 80 68

HTA 899

Les in barva meranti, RM 32
 Aplikacija nerjaveča pločevina
 Prijemalo P 3206

68	Ud (Wm ² /K)	80	Ud (Wm ² /K)
H	0,94*	H	0,83*
HA	0,94*	HA	0,83*



H HA 80 68

HTA 131

Les in barva smreka, RF/K 16, prečna struktura
Ral 7039
Steklo ornametno steklo
Prijemalo 316 866
Odkapna letev WSE 03

	68	Ud (Wm ² /K)	80	Ud (Wm ² /K)	
H	0,95	(Ug 0,7)	H	0,84	(Ug 0,6)
H	0,96	(Ug 1,1)	H	0,85	(Ug 0,7)
HA	0,94	(Ug 0,5)	HA	0,84	(Ug 0,5)



H HA 80 68

HTA 863B

Barva Ral 7039
Steklo ornametno steklo
Prijemalo P 3217 - črno

	68	Ud (Wm ² /K)	80	Ud (Wm ² /K)	
H	0,96	(Ug 0,7)	H	0,86	(Ug 0,6)
H	1,0	(Ug 1,1)	H	0,87	(Ug 0,7)
HA	0,94	(Ug 0,5)	HA	0,85	(Ug 0,5)



H HA 80 68

HT 863A / HSTT 400

Les in barva meranti, RM 22, prečna struktura
Ral 7039
Aplikacija nerjaveča pločevina
Steklo motiv peskano, SM 863A
Prijemalo P 3214
Odkapna letev WSE 02

	68	Ud (Wm ² /K)	80	Ud (Wm ² /K)	
H	0,96	(Ug 0,7)	H	0,86	(Ug 0,6)
H	1,0	(Ug 1,1)	H	0,87	(Ug 0,7)
HA	0,94	(Ug 0,5)	HA	0,85	(Ug 0,5)

H HA 80 68

HTA 919

Les in barva smreka, RF/K 10, prečna struktura
 Aplikacija Alu Ral 7006, nerjaveča pločevina
 Steklo motiv SG 895
 Prijemalo P 3214

	68	Ud (Wm ² /K)	80	Ud (Wm ² /K)	
H	0,98	(Ug 0,7)	H	0,86	(Ug 0,6)
H	1,0	(Ug 1,1)	H	0,87	(Ug 0,7)
HA	0,94	(Ug 0,5)	HA	0,85	(Ug 0,5)



H HA 68

HT 900 / HSTT 400

Les in barva hrast, RE 22, prečna struktura,
 Ral 7039
 Aplikacija Alu Ral 7021 FS
 nerjaveča pločevina
 Steklo ornamentno steklo
 Prijemalo 314 597

	68	Ud (Wm ² /K)
H	0,96	(Ug 0,7)
H	1,0	(Ug 1,1)
HA	0,94	(Ug 0,5)

H HA 80 68

HTA 920A

Barva Ral 7016
 Aplikacija Alu Dekor Zement svetli
 nerjaveča pločevina
 Steklo Ornamentno steklo
 Prijemalo P 3214
 Odpiranje na prstni odtis



	68	Ud (Wm ² /K)	80	Ud (Wm ² /K)	
H	0,97	(Ug 0,7)	H	0,87	(Ug 0,6)
H	1,0	(Ug 1,1)	H	0,88	(Ug 0,7)
HA	0,94	(Ug 0,5)	HA	0,85	(Ug 0,5)



H HA 80 68

HTA 906A

Les in barva smreka, RF/K 10, prečna struktura
 Aplikacija nerjaveča pločevina
 Steklo ornamentno steklo
 Prijemalo P 3214
 Odpiranje na prstni odtis

68	Ud (Wm ² /K)	80	Ud (Wm ² /K)
H	0,98 (Ug 0,7)	H	0,87 (Ug 0,6)
H	1,0 (Ug 1,1)	H	0,88 (Ug 0,7)
HA	0,94 (Ug 0,5)	HA	0,85 (Ug 0,5)



H HA 80 68

HT 862A / HSTT 400

Les in barva macesen, RL 23, prečna struktura
 Aplikacija Alu Dekor Beton temni
 Steklo motiv SG 862A, SM 862A
 Prijemalo P 3210

68	Ud (Wm ² /K)	80	Ud (Wm ² /K)
H	0,98 (Ug 0,7)	H	0,87 (Ug 0,6)
H	1,1 (Ug 1,1)	H	0,89 (Ug 0,7)
HA	0,94 (Ug 0,5)	HA	0,85 (Ug 0,5)



H HA 68

HT 906

Barva Ral 7024
 Aplikacija Alu Dekor Beton temni
 Steklo nerjaveča pločevina
 Prijemalo SG 906
 314 597

68	Ud (Wm ² /K)
H	0,98 (Ug 0,7)
H	1,0 (Ug 1,1)
HA	0,94 (Ug 0,5)



H HA 80 68

HTA 25 IA

Barva Ral 9002, Ral 9005
Steklo Ornamentno steklo
Prijemalo P 3217 - črno

68	Ud (Wm ² /K)	80	Ud (Wm ² /K)
H	0,95 (Ug 0,7)	H	0,84 (Ug 0,6)
H	0,95 (Ug 1,1)	H	0,84 (Ug 0,7)
HA	0,94 (Ug 0,5)	HA	0,84 (Ug 0,5)



H HA 80 68

HT 843 / HSTT 400

Les in barva meranti, RM 30
Ral 7039
Applikacija nerjaveča pločevina
Steklo Ornamentno steklo
Prijemalo P 3217
Odkapna letev WSE 02

68	Ud (Wm ² /K)	80	Ud (Wm ² /K)
H	0,95 (Ug 0,7)	H	0,84 (Ug 0,6)
H	0,96 (Ug 1,1)	H	0,84 (Ug 0,7)
HA	0,94 (Ug 0,5)	HA	0,84 (Ug 0,5)

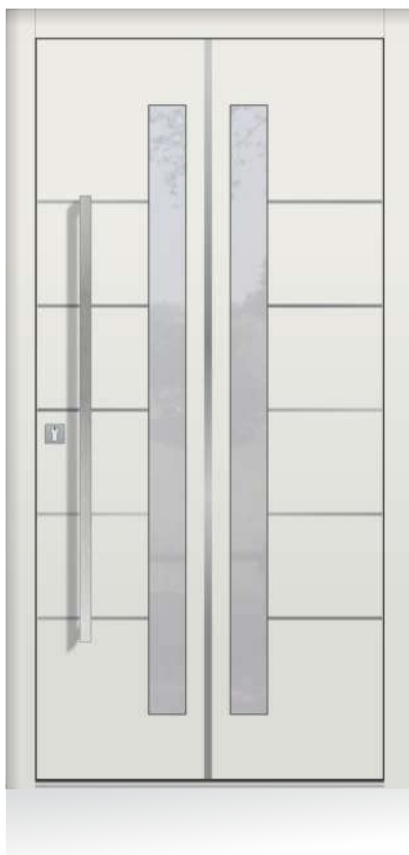

H HA 80 68

HTA 872

Barva Ral 9002
 Aplikacija nerjaveča pločevina
 Steklo ornamentno steklo
 Prijemalo 314 597

	68	Ud (Wm ² /K)	80	Ud (Wm ² /K)	
H	0,97	(Ug 0,7)	H	0,84	(Ug 0,6)
H	1,0	(Ug 1,1)	H	0,84	(Ug 0,7)
HA	0,94	(Ug 0,5)	HA	0,83	(Ug 0,5)



H HA 80 68

HTA 898A

Barva Ral 7039
 Prijemalo ZAE 66 - črno
 Odpiranje na prstni odtis

	68	Ud (Wm ² /K)	80	Ud (Wm ² /K)
H	0,94*		H	0,83*
HA	0,94*		HA	0,83*



H HA 68

HT 909 / HSTT 400

Barva Ral 7039
 Aplikacija Alu Dekor Altholz, prečna struktura
 nerjaveča pločevina
 Steklo motiv SM 909
 Hišna številka nerjaveča pločevina
 Prijemalo P 3212

	68	Ud (Wm ² /K)
H	0,94*	
HA	0,94*	



H HA 80 68

HT 265 / HSTT 400

Les in barva smreka, RF 200,
prečna struktura
Steklo motiv SM 265
Prijemalo 316 871 - črno

	68	Ud (Wm ² /K)	80	Ud (Wm ² /K)
H	0,94*		H	0,83*
HA	0,94*		HA	0,83*



H HA 80 68

HTA 265A

Les in barva smreka, RF/K 26
prečna struktura
Applikacija nerjaveča pločevina
Prijemalo ZAE 66

	68	Ud (Wm ² /K)	80	Ud (Wm ² /K)
H	0,94*		H	0,83*
HA	0,94*		HA	0,83*



H HA 80 68

HTA 946A

Barva Ral 9016
 Steklo motiv SG 946A
 Prijemalo P 3217
 Odpiranje na prstni odtis

68	Ud (Wm ² /K)	80	Ud (Wm ² /K)
H	0,98 (Ug 0,7)	H	0,87 (Ug 0,6)
H	1,0 (Ug 1,1)	H	0,88 (Ug 0,7)
HA	0,94 (Ug 0,5)	HA	0,85 (Ug 0,5)



H HA 80 68

HTA 944

Les in barva smreka, RF/K 27
 Steklo Ornamenno steklo
 Prijemalo P 3217
 Odpiranje na prstni odtis
 Odkapna letev WSE 03

68	Ud (Wm ² /K)	80	Ud (Wm ² /K)
H	0,97 (Ug 0,7)	H	0,86 (Ug 0,6)
H	1,0 (Ug 1,1)	H	0,87 (Ug 0,7)
HA	0,94 (Ug 0,5)	HA	0,85 (Ug 0,5)



H HA 80 68

HT 924A / HSTT 400

Les in barva smreka, RF/K 22
 Steklo motiv SG 924A, SM 924A
 Prijemalo ZAE 66 - črno

68	Ud (Wm ² /K)	80	Ud (Wm ² /K)
H	0,99 (Ug 0,7)	H	0,88 (Ug 0,6)
H	1,1 (Ug 1,1)	H	0,90 (Ug 0,7)
HA	0,94 (Ug 0,5)	HA	0,86 (Ug 0,5)



H HA 80 68

HT 806 / HSTT 400

Les in barva hrast, RE 200, prečna struktura
Ral 7039
Steklo motiv SG 806, SM 806
Prijemalo P 3217
Odkapna letev WSE 02

68	Ud (Wm ² /K)	80	Ud (Wm ² /K)
H	0,97 (Ug 0,7)	H	0,86 (Ug 0,6)
H	1,0 (Ug 1,1)	H	0,87 (Ug 0,7)
HA	0,94 (Ug 0,5)	HA	0,85 (Ug 0,5)



H HA 80 68

HTA 810

Les in barva hrast, RE 22, prečna struktura
Steklo motiv SG 810
Prijemalo ZAE 66
Odkapna letev WSE 03

68	Ud (Wm ² /K)	80	Ud (Wm ² /K)
H	0,97 (Ug 0,7)	H	0,86 (Ug 0,6)
H	1,0 (Ug 1,1)	H	0,88 (Ug 0,7)
HA	0,94 (Ug 0,5)	HA	0,85 (Ug 0,5)



H HA 80 68

HTA 258A

Les in barva RF/K 16, prečna struktura
 Steklo ornamentno steklo
 Prijemalo P 3217 - črno
 Odpiranje na prstni odtis

68	Ud (Wm ² /K)	80	Ud (Wm ² /K)
H	0,97 (Ug 0,7)	H	0,86 (Ug 0,6)
H	1,0 (Ug 1,1)	H	0,87 (Ug 0,7)
HA	0,94 (Ug 0,5)	HA	0,85 (Ug 0,5)



H HA 80 68

HTA 258

Les in barva smreka, RF/K 27
 Steklo Ornamentno steklo
 Prijemalo P 3214

68	Ud (Wm ² /K)	80	Ud (Wm ² /K)
H	0,97 (Ug 0,7)	H	0,86 (Ug 0,6)
H	1,0 (Ug 1,1)	H	0,87 (Ug 0,7)
HA	0,94 (Ug 0,5)	HA	0,85 (Ug 0,5)



H HA 68

HT 835 / HSTT 400

Barva Ral 9002
 Aplikacija Alu Precious Sand FS metalik
 Steklo motiv peskano, SM 835
 Prijemalo P 3214

68	Ud (Wm ² /K)
H	0,96 (Ug 0,7)
H	1,0 (Ug 1,1)
HA	0,94 (Ug 0,5)



H HA 80 68

HT 845 / HSTT 400

Les in barva smreka, RF/K 17,
prečna struktura, Ral 8019
Steklo motiv SM 845
Prijemalo 314 597
Odpiranje na prstni odtis

	68	Ud (Wm ² /K)	80	Ud (Wm ² /K)
H	0,94*		H	0,83*
HA	0,94*		HA	0,83*



H HA 80 68

HTA 866

Barva Ral 7016
Aplikacija nerjaveča pločevina
Steklo motiv SG 866
Prijemalo P 1182 s čitalcem na prstni odtis
Odkapna letev WSE 03

	68	Ud (Wm ² /K)	80	Ud (Wm ² /K)
H	1,0	(Ug 0,7)	H	0,87
H	1,1	(Ug 1,1)	H	0,89
HA	0,94	(Ug 0,5)	HA	0,85



H HA 80 68

HTA 934A

Les in barva smreka, RF/K 17
 Steklo ornamentno steklo
 Prijemalo P 3217 - črno
 Odpiranje na prstni odtis

68	Ud (Wm ² /K)	80	Ud (Wm ² /K)
H	0,97 (Ug 0,7)	H	0,86 (Ug 0,6)
H	1,0 (Ug 1,1)	H	0,87 (Ug 0,7)
HA	0,94 (Ug 0,5)	HA	0,85 (Ug 0,5)



H HA 80 68

HTA 934

Barva Ral 7012
 Aplikacija nerjaveča pločevina
 Steklo motiv SG 934
 Prijemalo P 3217
 Odkapna letev WSE 03

68	Ud (Wm ² /K)	80	Ud (Wm ² /K)
H	0,97 (Ug 0,7)	H	0,86 (Ug 0,6)
H	1,0 (Ug 1,1)	H	0,87 (Ug 0,7)
HA	0,94 (Ug 0,5)	HA	0,85 (Ug 0,5)



H HA 68

HT 947 / HSTT 400

Barva Ral 7016
 Steklo motiv peskano, SM 947
 Prijemalo 316 871 - črno
 Odpiranje na prstni odtis

68	Ud (Wm ² /K)
H	0,97 (Ug 0,7)
H	1,0 (Ug 1,1)
HA	0,94 (Ug 0,5)



H HA 68

HT 137

Barva Ral 7039
Steklo ornamentno steklo
Prijemalo P 3217 - črno
Odpiranje na prstni odtis

68	Ud (Wm ² /K)
H	0,98 (Ug 0,7)
H	1,1 (Ug 1,1)
HA	0,94 (Ug 0,5)



H HA 68

HT 849

Les in barva hrast, RE 200, Ral 7039
Steklo ornamentno steklo
Prijemalo 316 860
Led-Diode LI

68	Ud (Wm ² /K)
H	0,95 (Ug 0,7)
H	0,96 (Ug 1,1)
HA	0,94 (Ug 0,5)

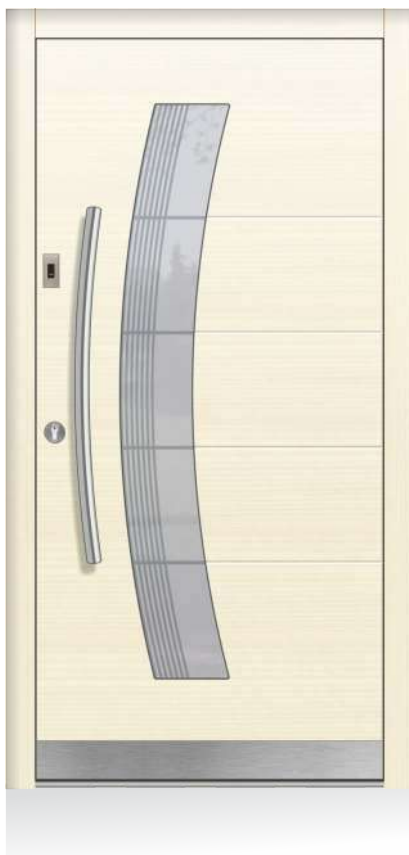

H HA 80 68

HTA 887B

Les in barva smreka, RF/K 10, prečna struktura
 Steklo motiv SG 887B
 Prijemalo ZAE 66R
 Odpiranje na prstni odtis
 Odkapna letev WSE 03

	68	Ud (Wm ² /K)	80	Ud (Wm ² /K)
H	1,0	(Ug 0,7)	H	0,90 (Ug 0,6)
H	1,1	(Ug 1,1)	H	0,91 (Ug 0,7)
HA	0,98	(Ug 0,5)	HA	0,89 (Ug 0,5)

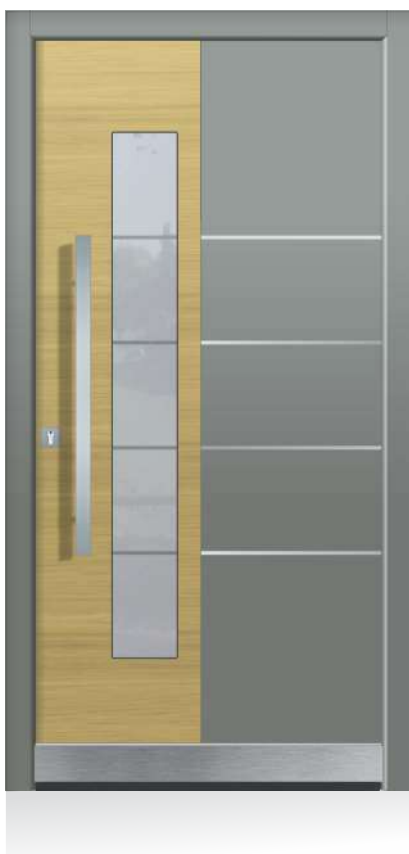

H HA 68

HT 894

Les in barva hrast, RE 200, prečna struktura, Ral 7037
 Aplikacija Alu Ral 7037
 nerjaveča pločevina
 Steklo motiv SG 894
 Prijemalo P 3217
 Odkapna letev WSE 02

	68	Ud (Wm ² /K)
H	0,97	(Ug 0,7)
H	1,0	(Ug 1,1)
HA	0,94	(Ug 0,5)



H HA 68

HT 887A / HSTT 400

Les in barva Ral 7037
 Aplikacija Alu HD Wenge, prečna struktura
 nerjaveča pločevina
 Steklo motiv peskano, SM 887
 Prijemalo ZAE 66R
 Odpiranje na prstni odtis
 Odkapna letev WSE 02

	68	Ud (Wm ² /K)
H	1,0	(Ug 0,7)
H	1,1	(Ug 1,1)
HA	0,98	(Ug 0,5)



H HA 68

HT 885A / HSTT 400

Barva Ral 9016, Ral 7042
 Aplikacija Alu Ral 7042
 Steklo motiv SG 885A, SM 885
 Prijemalo ZAE 66
 Odpiranje na prstni odtis

68	Ud (Wm ² /K)
H	1,0 (Ug 0,7)
H	1,1 (Ug 1,1)
HA	0,98 (Ug 0,5)



H HA 80 68

HTA 885

Barva Ral 7016, Ral 7042
 Aplikacija Alu Ral 7016 FS
 nerjaveča pločevina
 Steklo motiv AG 885
 Prijemalo ZAE 66

68	Ud (Wm ² /K)	80	Ud (Wm ² /K)
H	1,0 (Ug 0,7)	H	0,89 (Ug 0,6)
H	1,1 (Ug 1,1)	H	0,91 (Ug 0,7)
HA	0,98 (Ug 0,5)	HA	0,88 (Ug 0,5)



H HA 80 68

HTA 153A

Barva Ral 7021
 Steklo ornamentno steklo
 Prijemalo ZAE 66R
 Odpiranje na prstni odtis
 Odkapna letev WSE 03

68	Ud (Wm ² /K)	80	Ud (Wm ² /K)
H	0,96 (Ug 0,7)	H	0,84 (Ug 0,6)
H	0,99 (Ug 1,1)	H	0,85 (Ug 0,7)
HA	0,94 (Ug 0,5)	HA	0,84 (Ug 0,5)



H HA 80 68

HTA 883

Barva Ral 7016
 Aplikacija Alu Ral 7021 FS
 nerjaveča pločevina
 Steklo motiv SG 883A
 Prijemalo TG 60 ravna pritrditev

68	Ud (Wm ² /K)	80	Ud (Wm ² /K)
H	1,0 (Ug 0,7)	H	0,90 (Ug 0,6)
H	1,1 (Ug 1,1)	H	0,91 (Ug 0,7)
HA	0,98 (Ug 0,5)	HA	0,88 (Ug 0,5)



H HA 68

HT 255 / HSTT 400

Les in barva hrast, RE 200, prečna struktura
 Ral 7021, Ral 7039
 Steklo motiv peskano, SM 255
 Prijemalo F5/6

68	Ud (Wm ² /K)
H	0,99 (Ug 0,7)
H	1,0 (Ug 1,1)
HA	0,97 (Ug 0,5)

TREND RUSTICO



Površina krila je obojestransko obložena s furnirano, rahlo grčasto vezano ploščo v drevesni vrsti hrast. Na zunanji strani je krilo poravnano z okvirjem.

V kombinaciji s stekleno emajlirano aplikacijo, ali aplikacijo iz nerjaveče pločevine na zunanji strani, poveže tradicionalno z modernim. Široka paleta dodatkov vaši kreativnosti daje proste roke.



Aluminij obloga na zunanji strani okvirja

H 68/95 Les - vhodna vrata model

HTR 106B / HSTT 400

Les in barva hrast z grčami, RE 200
 obojestransko prečna struktura
 Farbe Alu Ral 9005 FS
 Steklo orn. Satinato belo
 Prijemalo P2/7 - črno
 Odpiranje na prstni odtis

68/95	Ud (Wm ² /K)
H	0,84*



H 68/95 Les - vhodna vrata model

HTR 107

Les in barva hrast z grčami, RE 22
 obojestransko pokončna struktura
 Prijemalo 316 872 - črno

68/95	Ud (Wm ² /K)
H	0,84*



H 68/95

HTR 102A

Les in barva hrast z grčami, RE 22,
obojestransko prečna struktura
Steklo orn. Satinato belo
Prijemalo 314 586

68/95 | Ud (Wm²/K)
H | **0,85** (Ug 0,5)



H 68/95

HTR 103A

Les in barva hrast z grčami, RE 200,
obojestransko prečna struktura
Steklo orn. Satinato belo
Prijemalo P 3217

68/95 | Ud (Wm²/K)
H | **0,86** (Ug 0,5)



H 68/95

HTR 106A

Les in barva hrast z grčami, RE 200,
obojestransko prečna struktura
Ral 7037
Prijemalo P 3214
Odpiranje na prstni odtis

68/95	Ud (Wm ² /K)
H	0,84*



H 68/95

HTR 105

Les in barva hrast z grčami, RE 200,
obojestransko prečna struktura
emajlirano steklo -RAL 9017
316 848 - črno
na prstni odtis

68/95	Ud (Wm ² /K)
H	0,84*



H 68/95

HTR 103

Les in barva hrast z grčami, RE 22,
obojestransko prečna struktura
Steklo motiv Satinato belo in emajlirano
steklo -RAL 9017
Prijemalo P 3217

68/95	Ud (Wm ² /K)
H	0,86 (Ug 0,5)

TREND LINE



Osnova vrat, okvir in krilo sta na voljo v poljubnih barvah in drevesnih vrstah. Na zunanjo stran krila so iz macesnovega ali hrastovega lesa pritrjene masivne letve, ki poravnane z okvirjem vrat ustvarijo 3D izgled. Površina letev je oljena.



68 Les - vhodna vrata model

HTL 268

Les in barva smreka, Ral 7021,
masivne letve, macesen oljene
Prijemalo 316 848 - črno

68	Ud (Wm ² /K)
H	0,94*



68 Les - vhodna vrata model

HTL 100 / HSTT 400

Les in barva smreka, Ral 7021,
masivne letve, macesen oljene
Steklo ornamentno steklo
Prijemalo 316 872 - črno

68	Ud (Wm ² /K)
H	0,94*



H 68

HTL 272

Les in barva smreka, Ral 7037
masivne letve, macesen oljene
Steklo ornamentno steklo
Prijemalo 314 598

68 | Ud (Wm²/K)
H | **0,96** (Ug 0,7)



H 68

HTL 103

Les in barva smreka, Ral 7039
masivne letve, macesen oljene
Steklo Satinato belo in emajlirano steklo -RAL 9017
Prijemalo P 3217 - črno

68 | Ud (Wm²/K)
H | **0,96** (Ug 0,7)



H 68

HTL 269

Les in barva meranti, Ral 8019
masivne letve, macesen oljene
Aplikacija nerjaveča pločevina
Prijemalo P 3217

68 | Ud (Wm²/K)
H | 0,94*



H 68

HTL 105

Les in barva smreka, Ral 7016
masivne letve,
macesen oljene
Aplikacija emjirano steklo
- RAL 9017
Prijemalo P 3217 - črno

68 | Ud (Wm²/K)
H | 0,94*



H 68

HTL 270

Les in barva macesen, RL 200
masivne letve, macesen oljene
Aplikacija Alu Night Grey FSM
Steklo ornamentno steklo
Prijemalo 3 16 609

68 | Ud (Wm²/K)
H | 0,95 (Ug 0,7)

TREND HBF



Moderna vrata z aplikacijo iz furnirane, rahlo grčaste vezane plošče v drevesni vrsti hrast. Kombinacija rustikalnega in modernega ustvari poseben vtis.



H 68 Les - vhodna vrata model

HBF 919A

Barva Ral 7016
 Aplikacija hrast z grčami, RE 200 prečna struktura
 nerjaveča pločevina
 Steklo motiv SG 895
 Prijemalo 314 597
 Odpiranje na prstni odtis

68 | Ud (Wm²/K)
 H | **0,97** (Ug 0,7)



H 68 Les - vhodna vrata model

HBF 894

Barva Ral 9002
 Aplikacija hrast z grčami, RE 200, prečna struktura
 Steklo ornamentno steklo
 Prijemalo TG 140 ravna pritrditev

68 | Ud (Wm²/K)
 H | **0,97** (Ug 0,7)



H 68

HBF 911A / HSTT 400

Barva Ral 7016
 Aplikacija hrast z grčami, RE 200, prečna struktura,
 nerjaveča pločevina
 Steklo motiv SM 911
 Prijemalo 314 597

68 | Ud (Wm²/K)
 H | 0,94*



H 68

HBF 266B

Barva Ral 7039
 Aplikacija hrast z grčami, RE 200, prečna struktura,
 Prijemalo 314 597

68 | Ud (Wm²/K)
 H | 0,94*



H 68

HBF 123

Barva Ral 7044
Aplikacija hrast z grčami, RE 200, prečna struktura
Prijemalo 316 871 - črno
Odpiranje na prstni odtis

68 | Ud (Wm²/K)
H | **0,94***



H 68

HBF 906

Barva Ral 7021
Aplikacija hrast z grčami, RE 200, prečna struktura, nerjaveča pločevina
Steklo ornamentno steklo
Prijemalo P 3217

68 | Ud (Wm²/K)
H | **0,98** (Ug 0,7)



H 68

HBF 845 / HSTT 400

Barva Ral 7016, Ral 9005
Aplikacija hrast z grčami, RE 200, prečna struktura
Steklo motiv SM 845
Prijemalo ZAE 66 - črno
Odpiranje na prstni odtis

68 | Ud (Wm²/K)
H | **0,94***

DELUXE



Prestižna serija vhodnih vrat DELUXE za tiste, ki hočete nekaj več. Unikaten dizajn skladen z impresivnimi zasteklitvenimi aplikacijami iz aluminija in inoxa, so značilnost te serije. Izbor barvne kombinacije, prijemala, led svetil in ostale opreme za vaša idealna vrata pa prepuščamo vaši domišljiji in lastni kreativnosti.



HA 68 Les/alu - vhodna vrata model

HAD 852A

Barva Alu Original Platinum
Aplikacija Alu Carbon Night
Steklo ornamentno steklo
Prijemalo 316 872 - črno

68 | Ud (Wm²/K)
HA | **0,94** (Ug 0,5)



H 68 Les - vhodna vrata model

HD 852A

Les in barva hrast RE 200, prečna struktura
Ral 7016
Aplikacija Alu Ral 7016 FS
Steklo ornamentno steklo
Prijemalo 316 872 - črno

68 | Ud (Wm²/K)
H | **0,94** (Ug 0,5)
H | **0,95** (Ug 0,7)
H | **0,97** (Ug 1,1)



H HA 68

HD 801A / HSTT 400

Les in barva hrast, RE 22, Ral 7016
 Aplikacija nerjaveča pločevina
 Steklo ornamentno steklo
 Prijemalo P 3217

68	Ud (Wm ² /K)
H	0,94 (Ug 0,5)
H	0,96 (Ug 0,7)
H	0,99 (Ug 1,1)
HA	0,94 (Ug 0,5)



H HA 68

HD 168

Barva Ral 9002
 Aplikacija Alu Ral 7004 FS
 nerjaveča pločevina
 Steklo ornamentno steklo
 Prijemalo ZAE 66

68	Ud (Wm ² /K)
H	0,98 (Ug 0,5)
H	1,0 (Ug 0,7)
H	1,1 (Ug 1,1)
HA	0,98 (Ug 0,5)



H HA 68

HD 875C

Les in barva smreka, RF/K 27
 Aplikacija nerjaveča pločevina
 Steklo ornamentno steklo
 Prijemalo P 3217

68	Ud (Wm ² /K)
H	0,94 (Ug 0,5)
H	0,97 (Ug 0,7)
H	1,0 (Ug 1,1)
HA	0,94 (Ug 0,5)



H HA 68

HD 945

Les in barva smreka, RF/K 16
 prečna struktura
 Aplikacija nerjaveča pločevina
 Steklo ornamentno steklo
 Prijemalo ZAE 66
 Odpiranje na prstni odtis

68	Ud (Wm ² /K)
H	0,94 (Ug 0,5)
H	0,97 (Ug 0,7)
H	1,0 (Ug 1,1)
HA	0,94 (Ug 0,5)

H HA 68

HD 945 / HSTT 400

Barva Ral 7016
 Aplikacija nerjaveča pločevina
 Steklo motiv SG 945, SM 945
 Prijemalo SG-124 s čitalcem na prstni odtis

68	Ud (Wm ² /K)
H	0,94 (Ug 0,5)
H	0,97 (Ug 0,7)
H	1,0 (Ug 1,1)
HA	0,94 (Ug 0,5)

Lesena vhodna vrata 68&68/95
Les/aluminij vhodna vrata 68

MODERN



Za lesena in les/aluminij vhodna vrata iz serije MODERN so značilne elegantne linije in preverjene oblike. Zasteklitveni okvirček na zunanji strani vrat poudari estetsko obliko vrat in jih naredi še bolj impulzantne. Vsaka vrata iz serije MODERN lahko opremite s prijmalom in barvo iz inlesove obširne kolekcije ter vanje vključite opremo po svojih željah (led svetila, odpiranje na prstni odtis, hišna številka, varnostna oprema...).



HA 68 Les/alu - vhodna vrata model

HAM 172C

Barva Alu Ral 9005 FS
 Aplikacija Alu Dekor Stadelholz siv, prečna struktura
 Steklo ornamentno steklo
 Prijemalo P 3217
 Odpiranje na prstni odtis

68	Ud (Wm ² /K)
HA	0,94 (Ug 0,5)



H 68 68/95 Les - vhodna vrata model

HM 172C

Les in barva smreka, RF/K 16
 Aplikacija Alu Ral 7021 FS
 Steklo ornamentno steklo
 Prijemalo P 3217
 Odpiranje na prstni odtis

68	Ud (Wm ² /K)	68/95	Ud (Wm ² /K)
H	0,96 (Ug 0,7)	H	0,69 (Ug 0,5)
H	1,0 (Ug 1,1)		

**NIEDRIG
ENERGIE**

Lesena vhodna vrata 68&68/95
 Les/aluminij vhodna vrata 68

MODERN



H 68 68/95

HA 68

HM 134B

Les in barva hrast, RE 200,
 Ral 7021
 Steklo Ornamentno steklo
 Prijemalo 3 16 871 - črno

68	Ud (Wm ² /K)	68/95	Ud (Wm ² /K)
H	0,97 (Ug 0,7)	H	0,70 (Ug 0,5)
H	1,0 (Ug 1,1)		
HA	0,94 (Ug 0,5)		

**NIEDRIG
 ENERGIE**



H 68 68/95

HA 68

HM 222

Les in barva smreka, RF/K 27
 Okrasne prečke 3 x tip I
 Steklo Ornamentno steklo
 Prijemalo TG 50

68	Ud (Wm ² /K)	68/95	Ud (Wm ² /K)
H	0,96 (Ug 0,7)	H	0,69 (Ug 0,5)
H	1,0 (Ug 1,1)		
HA	0,94 (Ug 0,5)		

**NIEDRIG
 ENERGIE**



H 68 68/95

HA 68

HM 875C

Les in barva meranti, RM 22
Steklo ornamentno steklo
Prijemalo ZAE 66

68	Ud (Wm ² /K)	68/95	Ud (Wm ² /K)
H	0,97 (Ug 0,7)	H	0,7 (Ug 0,5)
H	1,0 (Ug 1,1)		
HA	0,94 (Ug 0,5)		

**NIEDRIG
ENERGIE**



H 68 68/95

HA 68

HM 180

Les in barva meranti, RM 22
Steklo ornamentno steklo
Prijemalo 316 866

68	Ud (Wm ² /K)	68/95	Ud (Wm ² /K)
H	0,99 (Ug 0,7)	H	0,72 (Ug 0,5)
H	1,1 (Ug 1,1)		
HA	0,95 (Ug 0,5)		

**NIEDRIG
ENERGIE**

Lesena vhodna vrata 68&68/95
 Les/aluminij vhodna vrata 68

MODERN



H 68 68/95

HA 68

HM 133A

Les in barva smreka, RF/K 16
 Steklo ornamentno steklo
 Prijemalo P 3217 - črno

	68	Ud (Wm ² /K)	68/95	Ud (Wm ² /K)
H	0,95	(Ug 0,7)	H	0,68 (Ug 0,5)
H	1,0	(Ug 1,1)		
HA	0,94	(Ug 0,5)		

**NIEDRIG
 ENERGIE**



H 68 68/95

HA 68

HM 131

Les in barva smreka, RF/K 26
 Steklo SG 131, SG 131A
 Prijemalo 316 866
 Odkapna letev WSE 02

	68	Ud (Wm ² /K)	68/95	Ud (Wm ² /K)
H	0,95	(Ug 0,7)	H	0,74 (Ug 0,5)
H	0,98	(Ug 1,1)		
HA	0,94	(Ug 0,5)		

**NIEDRIG
 ENERGIE**



H 68 68/95

HA 68

HM 132A

Barva smreka, RF/K 10
Steklo motiv ornamentno steklo
Prijemalo 314 586

68	Ud (Wm ² /K)	68/95	Ud (Wm ² /K)
H	0,96 (Ug 0,7)	H	0,69 (Ug 0,5)
H	0,99 (Ug 1,1)		
HA	0,94 (Ug 0,5)		

**NIEDRIG
ENERGIE**



H 68 68/95

HA 68

HM 170

Les in barva meranti, RM 22
prečna struktura
Steklo ornamentno steklo
Prijemalo P 3217 - črno

68	Ud (Wm ² /K)	68/95	Ud (Wm ² /K)
H	0,95 (Ug 0,7)	H	0,68 (Ug 0,5)
H	0,97 (Ug 1,1)		
HA	0,94 (Ug 0,5)		

**NIEDRIG
ENERGIE**

NIZKOENERGIJSKO

Odlične vrednosti do $U_d=0,67 \text{ W/m}^2\text{K}$ dosegajo rolingi tipa Ferro Klassikplus v debelini 95mm.



H 68/95

**NIEDRIG
ENERGIE**

HT 100

FERRO KLASSIKPLUS

Les in barva Fichte, RF/K 16
Prijemalo prečna struktura
P 3217 - črno

68/95 | $U_d \text{ (Wm}^2\text{/K)}$

H | **0,67***

PASIVNO

Lesena vhodna vrata iz rolinga debeline 98 mm so z ustreznim certifikatom posebej izdelana za vgradnjo v pasivne hiše.

Zertifikat
Zertifizierte Passivhaus Komponente
Für klimagerechte Klima, gültig bis 31.12.2014

Passivhaus Institut
Dr. Wolfgang Feist
64283 Darmstadt
Germany

Kategorie: **Haustür mit Verglasung**
Hersteller: **Moralt AG**
Produktname: **Moralt Outdoor FERRO Passiv**

Folgende Kriterien wurden für die Zuerkennung des Zertifikates geprüft:

Wärmehaushalt der eingebauten Haustür:
Die Tür erreicht bei einer Größe von 1,10 m / 2,20m im eingebauten Zustand einen U-Wert von
U_{d, eingebaut} = 0,80 W/m²K ± 0,80 W/m²K
wenn die im zugehörigen Bericht (beim Hersteller erhältlich) dokumentierten Einbaudetails der Haustür eingehalten werden.
Ohne Einbau beträgt der U-Wert der Tür U_d = 0,77 W/m²K.
Bei der Berechnung der U_d wurde eine Verglasung mit U_v = 0,80 W/m²K (Aufbau: 4/16/4/16, U_v nach EN 673) und der Absenktanker "Thermor" ange-
nommen. Der sichtbare Teil der Verglasung darf maximal eine Fläche von 0,008 m²
z. Bsp. 10 x 118 (137 cm) und einen Abstand von 4,00 m z. Bsp. 11 x 11 x
33 (135 cm) aufweisen, um die genannten U-Werte nicht zu überschreiten.

Luftdichtheit:
Die Haustür erreicht die Luftdichtheitsklasse 3 nach EN 12207.
Das Zertifikats-Kriterium "Luftdichtheit" wird erfüllt.
Bei der Prüfung der Luftdichtheitsklasse nach EN 12207 wurde eine maximale
Verformung des Türbalkens ermittelt durch Zylinderprüfung nach EN 1121,
berücksichtigt. Die Luftdichtheitsprüfung wurde mit einer Haustür ohne
Verglasung durchgeführt.

¹⁾ Bei dieser Haustür-Variante mit Verglasung sind für den Hausklimaanbau und
im Randbereich des Türbalkens nur Holz mit $\lambda \leq 0,13$ W/mK eingesetzt. Die
Dämmung des Türbalkens besteht aus PU-Schaum mit $\lambda = 0,035$ W/mK.

Haustür-U-Wert
inklusive oben beschriebener
Verglasung mit U_v = 0,80 W/m²K
U_d = 0,77 W/m²K

Weitere Angaben sind im zugehörigen Datenblatt aufgeführt.
www.passiv.de (0144020)

ZERTIFIZIERTE
KOMponente
Passivhaus Institut



H 98 **PASSIV**

HT 264
FERRO PASSIV

Les in barva smreka RF/K 25,
prečna struktura
Aplikacija nerjaveča pločevina
Prijemalo P 3214

U_d = 0,80 W/m²K



TREND NOVO



Lesena vhodna vrata z zasteklitveno letvico na zunanji in notranji strani.

Vrata v obojestransko poravnani izvedbi krila in s skritimi nasadili, zagotavljajo sodoben in privlačen videz.

Široka paleta barv in dodatkov po vaši izbiri.



H 80 Les - vhodna vrata model

HTN 102

Les in barva hrast, RE 200, Ral 7016
Steklo ornamentno steklo
Prijemalo 316 866

80	Ud (Wm ² /K)
H	0,86 (Ug 0,6)
H	0,87 (Ug 0,7)



H 80 Les - vhodna vrata model

HTN 102

Barva Ral 7016
Steklo ornamentno steklo
Prijemalo P 3214
Odkapna letev WSE 03

80	Ud (Wm ² /K)
H	0,86 (Ug 0,6)
H	0,87 (Ug 0,7)



H 80

HTN 103

Les in barva smreka, RF/K 16
 Steklo Ornamenno steklo
 Prijemalo P 3217 - črno

80	Ud (Wm ² /K)
H	0,88 (Ug 0,6)
H	0,91 (Ug 0,7)



H 80

HTN 101

Barva Ral 7012
 Steklo Ornamenno steklo
 Prijemalo 316 866

80	Ud (Wm ² /K)
H	0,98 (Ug 0,6)
H	1,0 (Ug 0,7)



H 80

HTN 103

Barva Ral 7016
Steklo ornamentno steklo
Prijemalo P 3217
Odkapna letev WSE 03

80	Ud (Wm ² /K)
H	0,88 (Ug 0,6)
H	0,91 (Ug 0,7)



H 80

HTN 104

Les in barva hrast, RE 22
Steklo ornamentno steklo
Prijemalo 316 866

80	Ud (Wm ² /K)
H	0,92 (Ug 0,6)
H	0,97 (Ug 0,7)

KLASSICO ETA



Lesena vhodna vrata iz masivnega lesa z zasteklitveno letvico na zunanji in notranji strani. Vrata v obojestransko poravnani izvedbi krila in skritimi nasadili zagotavljajo sodoben in privlačen videz.



H 80 Les - vhodna vrata model

HCKE 400

Les in barva smreka, RF/K 27
Steklo ornamentno steklo
Prijemalo TG 160

80	Ud (Wm ² /K)
H	0,96 (Ug 0,6)
H	1,0 (Ug 0,7)



H 80 Les - vhodna vrata model

HCKE 402

Les in barva meranti, RM 32
Steklo ornamentno steklo
Prijemalo 316 867

80	Ud (Wm ² /K)
H	1,0 (Ug 0,6)
H	1,1 (Ug 0,7)



H 80

HCKE 40 IP

Les in barva smreka, RF/K 26
 Steklo ornamentno steklo
 Kljuka 314 839

80	Ud (Wm ² /K)
H	1,1 (Ug 0,6)
H	1,1 (Ug 0,7)



H 80

HCKE 40 I

Les in barva hrast, RE 200
 Steklo ornamentno steklo
 Prijemalo ZAE 706

80	Ud (Wm ² /K)
H	1,0 (Ug 0,6)
H	1,1 (Ug 0,7)



H 80

HCKE 407

Les in barva hrast, RE 22
Steklo ornamentno steklo
Prijemalo 316 602

80	Ud (Wm ² /K)
H	1,1 (Ug 0,6)
H	1,1 (Ug 0,7)



H 80

HCGE 051

Les in barva macesen, RL 23
Steklo ornamentno steklo
Kljuka 314 838

80	Ud (Wm ² /K)
H	1,1 (Ug 0,6)
H	1,1 (Ug 0,7)

KLASSICO



Vrata s klasično oblikovano strukturo.



H 68 Les - vhodna vrata model

HCK 418

Les in barva hrast, RE 22
Steklo ornamentno steklo
Kljuka 316 733

68	Ud (Wm ² /K)
H	1,3 (Ug 0,7)
H	1,4 (Ug 1,1)



H HA 68 Les - vhodna vrata model

HCK 400

Les in barva macesen, RL Ö1
Steklo motiv SG 867
Prijemalo TG 160

68	Ud (Wm ² /K)
H	1,2 (Ug 0,7)
H	1,4 (Ug 1,1)
HA	1,1 (Ug 0,5)



H 68

HCK 403

Les in barva smreka, RF 200
 Steklo ornamentno steklo
 Prijemalo TG 60

68	Ud (Wm ² /K)
H	1,3 (Ug 0,7)
H	1,5 (Ug 1,1)



H HA 68

HCK 401

Les in barva smreka, RF 200
 Steklo ornamentno steklo
 Prijemalo TG 160

68	Ud (Wm ² /K)
H	1,2 (Ug 0,7)
H	1,4 (Ug 1,1)
HA	1,1 (Ug 0,5)



H 68

HCK 406

Les in barva macesen, RL 200
Steklo ornametno steklo
Prijemalo 316 866

68	Ud (Wm ² /K)
H	1,4 (Ug 0,7)
H	1,5 (Ug 1,1)



H 68

HCK 405

Les in barva smreka, RF/K 15
Steklo ornametno steklo
Prijemalo TG 160

68	Ud (Wm ² /K)
H	1,3 (Ug 0,7)
H	1,5 (Ug 1,1)



H 68

HCK 404 / HSTC 400

Les in barva meranti, RM 32
Steklo ornametno steklo
Kljuka 314 838

68	Ud (Wm ² /K)
H	1,3 (Ug 0,7)
H	1,5 (Ug 1,1)



H 68

HCK 407

Les in barva macesen, RL ÖI
 Steklo motiv BV 64
 Kljuka 316 695

68	Ud (Wm ² /K)
H	1,2 (Ug 0,7)
H	1,4 (Ug 1,1)



H 68

HCK 408

Les in barva smreka, RAL 6003
 Steklo ornamentno steklo
 Kljuka 316 733

68	Ud (Wm ² /K)
H	1,3 (Ug 0,7)
H	1,4 (Ug 1,1)



H 68

HCK 409

Les in barva smreka, RAL 5003
Steklo ornamentno steklo
Kljuka 314 839

68	Ud (Wm ² /K)
H 1,3	(Ug 0,7)
H 1,4	(Ug 1,1)



H 68

HCK 424 / HSTC 400

Les in barva meranti, RM 30
Steklo ornamentno steklo
Kljuka 316 733



H 68

HCK 417

Les in barva meranti, RM 30
Steklo ornamentno steklo
Kljuka 316 733

68	Ud (Wm ² /K)
H 1,4	(Ug 0,7)
H 1,5	(Ug 1,1)

68	Ud (Wm ² /K)
H 1,3	(Ug 0,7)
H 1,4	(Ug 1,1)



H 68

HCK 422

Les in barva hrast, RE 22
Kljuka 316 733

68	Ud (Wm ² /K)
H	1,3*



H 68

HCK 420

Les in barva macesen, RL 200
Kljuka 316 733

68	Ud (Wm ² /K)
H	1,3*



H 68

HCK 425

Les in barva meranti, RM 22
Steklo ornamentno steklo
Kljuka 314 839

68	Ud (Wm ² /K)
H	1,3 (Ug 0,7)
H	1,4 (Ug 1,1)



H 68

HCK 419 / OL 101

Les in barva smreka, Ral 8017
Kljuka 316 695

68	Ud (Wm ² /K)
H	1,3*



H 68

HCK 410

Les in barva macesen, RL Ö1
Steklo ornamentno steklo
Kljuka 314 839

68	Ud (Wm ² /K)
H	1,3 (Ug 0,7)
H	1,5 (Ug 1,1)



H 68

HCK 402

Les in barva smreka, RF 200
Prijemalo TG 120

68	Ud (Wm ² /K)
H	1,2 (Ug 0,7)
H	1,4 (Ug 1,1)



H 68

HCK 427

Les in barva smreka, RF/K 27
Steklo ornamentno steklo
Kljuka 316 733

68	Ud (Wm ² /K)
H	1,4 (Ug 0,7)
H	1,4 (Ug 1,1)



H 68

HCK 415

Les in barva macesen, RL 200
Steklo ornamentno steklo
Kljuka 316 869

68	Ud (Wm ² /K)
H	1,4 (Ug 0,7)
H	1,5 (Ug 1,1)



H 68

HCK 411

Les in barva smreka, Ral 1020
Steklo ornamentno steklo
Kljuka ZAE 705

68	Ud (Wm ² /K)
H	1,3 (Ug 0,7)
H	1,5 (Ug 1,1)



H 68

HCK 413 / HSTC 413A

Les in barva meranti, RM 30
Steklo ornamentno steklo
Kljuka 316 733

68	Ud (Wm ² /K)
H	1,3 (Ug 0,7)
H	1,4 (Ug 1,1)

ANTICO

Das Bild ist symbolisch.



Vrata z najdaljšo tradicijo.



H 68 Les - vhodna vrata model

HCA 605

Les in barva hrast, RE 22
Steklo ornamentno steklo
Kljuka 319 567

68	Ud (Wm ² /K)
H	1,3 (Ug 0,7)
H	1,5 (Ug 1,1)



Model vrat HCA 612 je dobavljiv le v odtenkih RG1, RLÖ1, REÖ1, RF200, RL200, RE200 ter v vseh pokrivnih Ral barvah.

H 68 Les - vhodna vrata model

HCA 612

Les in barva smreka, Ral 6000
Steklo ornamentno steklo
Prijemalo 316 255

68	Ud (Wm ² /K)
H	1,3 (Ug 0,7)
H	1,4 (Ug 1,1)

68	Ud (Wm ² /K)	H 68
H	1,3 (Ug 0,7)	HCA 603
H	1,4 (Ug 1,1)	

Les in barva smreka, Ral 6005
 Steklo motiv SG 317
 Kljuka 314 839



Model vrat HCA 611 je dobavljiv le v odtenkih RGI, RLÖI, REÖI, RF200, RL200, RE200 ter v vseh pokrivnih Ral barvah.



H 68

HCA 611

Les in barva smreka, Ral 6021
 Steklo ornamentno steklo
 Kljuka 316 254

68	Ud (Wm ² /K)
H	1,3 (Ug 0,7)
H	1,4 (Ug 1,1)

H 68

HCA 610

Les in barva hrast, RE 21
 Steklo ornamentno steklo
 Kljuka 316 255

68	Ud (Wm ² /K)
H	1,3 (Ug 0,7)
H	1,4 (Ug 1,1)





H 68

HCA 607

Les in barva hrast, RE 22
Steklo motiv SG 325
Kljuka 319 567

68	Ud (Wm ² /K)
H	1,4 (Ug 0,7)
H	1,5 (Ug 1,1)



H 68

HCA 601

Les in barva macesen, RL 200
Steklo ornamentno steklo
Kljuka 316 254

68	Ud (Wm ² /K)
H	1,3 (Ug 0,7)
H	1,4 (Ug 1,1)



H 68

HCA 602

Les in barva macesen, RL 22
Steklo ornamentno steklo
Kljuka 314 839

68	Ud (Wm ² /K)
H	1,3 (Ug 0,7)
H	1,4 (Ug 1,1)

RUSTICO

Slika je simbolična.



Vrata oblikovana v želji po nostalgичnem vzdušju.



H 68 Les - vhodna vrata model

HCR 544

Les in barva meranti, RM 30
Steklo ornamentno steklo
Kljuka 316 602

68	Ud (Wm ² /K)
H	1,3 (Ug 0,7)
H	1,4 (Ug 1,1)



H 68 Les - vhodna vrata model

HCR 545

Les in barva macesen, RL 200
Steklo ornamentno steklo
Prijemalo 319 567

68	Ud (Wm ² /K)
H	1,3 (Ug 0,7)
H	1,4 (Ug 1,1)



H 68

HCR 502

Les in barva macesen, RL 22
 Steklo motiv SG 318
 Kljuka 319 567

68	Ud (Wm ² /K)
H	1,3 (Ug 0,7)
H	1,4 (Ug 1,1)



H 68

HCR 534

Les in barva smreka, Ral 6021
 Steklo motiv SG 323
 Kljuka 316 689

68	Ud (Wm ² /K)
H	1,3 (Ug 0,7)
H	1,4 (Ug 1,1)



H 68

HCR 507

Les in barva macesen, RL 200
Steklo ornamentno steklo
Kljuka 314 839

68	Ud (Wm ² /K)
H	1,4 (Ug 0,7)
H	1,5 (Ug 1,1)



H 68

HCR 539

Les in barva meranti, RM 32
Steklo ornamentno steklo
Kljuka 316 652

68	Ud (Wm ² /K)
H	1,4 (Ug 0,7)
H	1,5 (Ug 1,1)



H 68

HCR 535

Les in barva meranti, RM 30
 Steklo motiv SG 316
 Trkalo 253 941
 Kljuka 316 660

68	Ud (Wm ² /K)
H	1,3 (Ug 0,7)
H	1,4 (Ug 1,1)



H 68

HCR 504

Les in barva meranti, RM 32
 Steklo ornamentno steklo
 Kljuka 316 689

68	Ud (Wm ² /K)
H	1,4 (Ug 0,7)
H	1,5 (Ug 1,1)



H 68

HCR 501

Les in barva smreka, Ral 6013
Steklo motiv BV 67
Kljuka 316 695

68	Ud (Wm ² /K)
H 1,3	(Ug 0,7)
H 1,4	(Ug 1,1)



H 68

HCR 503

Les in barva smreka, Ral 6003
Steklo ornamentno steklo
Kljuka 316 689

68	Ud (Wm ² /K)
H 1,3	(Ug 0,7)
H 1,4	(Ug 1,1)



H 68

HCR 525

Les in barva macesen, RL 200
 Steklo ornamentno steklo
 Kljuka 316 733

68	Ud (Wm ² /K)
H	1,4 (Ug 0,7)
H	1,5 (Ug 1,1)



H 68

HCR 530

Les in barva smreka, RF/K 10
 Steklo ornamentno steklo
 Kljuka 316 695

68	Ud (Wm ² /K)
H	1,3 (Ug 0,7)
H	1,4 (Ug 1,1)



H 68

HCR 515

Les in barva meranti, RM 32
Steklo ornamentno steklo
Kljuka 314 838

68	Ud (Wm ² /K)
H	1,3 (Ug 0,7)
H	1,5 (Ug 1,1)



H 68

HCR 514

Les in barva macesen, RL 22
Steklo ornamentno steklo
Kljuka 314 839

68	Ud (Wm ² /K)
H	1,3 (Ug 0,7)
H	1,4 (Ug 1,1)



H 68

HCR 517

Les in barva meranti, RM 24
Steklo ornamentno steklo
Kljuka 316 695

68	Ud (Wm ² /K)
H	1,3 (Ug 0,7)
H	1,4 (Ug 1,1)

NEOKLASSICO



Vrata, ki na svojstven način povezujejo tradicijo z individualnostjo.



68 Les - vhodna vrata model

HCN 722

Les in barva macesen, RL 200
Steklo motiv ornamentno steklo
Prijemalo TG 160

68	Ud (Wm ² /K)
H	1,3 (Ug 0,7)
H	1,4 (Ug 1,1)



68 Les - vhodna vrata model

HCN 711

Les in barva smreka, RF 200
Prijemalo TG 160

68	Ud (Wm ² /K)
H	1,3*



H 68

HCN 739

Les in barva meranti, RM 22
 Steklo ornamentno steklo
 Prijemalo 314 839

68	Ud (Wm ² /K)
H 1,3	(Ug 0,7)
H 1,4	(Ug 1,1)



H 68

HCN 706

Les in barva smreka, RF/K 27
 Steklo ornamentno steklo
 Kljuka 316 695

68	Ud (Wm ² /K)
H 1,4	(Ug 0,7)
H 1,4	(Ug 1,1)



H 68

HCN 729

Les in barva macesen, RL 22
Steklo ornametno steklo
Kljuka 316 695

68	Ud (Wm ² /K)
H	1,4 (Ug 0,7)
H	1,4 (Ug 1,1)



H 68

HCN 731

Les in barva meranti, RM 30
Steklo ornametno steklo
Kljuka 316 695

68	Ud (Wm ² /K)
H	1,4 (Ug 0,7)
H	1,4 (Ug 1,1)



H 68

HCN 741

Les in barva smreka, Ral 1000
Steklo ornametno steklo
Kljuka TG 160

68	Ud (Wm ² /K)
H	1,3 (Ug 0,7)
H	1,4 (Ug 1,1)

H 68

68	Ud (Wm ² /K)
H	1,3 (Ug 0,7)
H	1,3 (Ug 1,1)

HCN 728

Les in barva smreka, RF/K 27
 Steklo ornamentno steklo
 Kljuka 314 839



H 68

HCN 708

Les in barva macesen, RL 23
 Steklo ornamentno steklo
 Kljuka 314 839

H 68

HCN 713

Les in barva macesen, RL ÖL
 Steklo ornamentno steklo
 Prijemalo TG 160

68	Ud (Wm ² /K)
H	1,3*

68	Ud (Wm ² /K)
H	1,3 (Ug 0,7)
H	1,4 (Ug 1,1)





H 68

HCN 727

Les in barva meranti, RM 22
Steklo ornamentno steklo
Kljuka 316 602

68	Ud (Wm ² /K)
H 1,3	(Ug 0,7)
H 1,4	(Ug 1,1)



H 68

HCN 742

Les in barva macesen, RL ÖL
Steklo ornamentno steklo
Kljuka 314 838

68	Ud (Wm ² /K)
H 1,4	(Ug 0,7)
H 1,4	(Ug 1,1)



H 68

HCN 714

Les in barva macesen, RL ÖL
Steklo ornamentno steklo
Kljuka 316 733

68	Ud (Wm ² /K)
H 1,3	(Ug 0,7)
H 1,4	(Ug 1,1)



H 68

HCN 709

Les in barva macesen, RL ÖL
Prijemalo 316 733

68	Ud (Wm ² /K)
H	1,3*



H 68

HCN 730

Les in barva meranti, RM 30
Steklo ornamentno steklo
Kljuka 316 733

68	Ud (Wm ² /K)
H	1,4 (Ug 0,7)
H	1,5 (Ug 1,1)

STRANSKA VRATA



H 68

HCG 050

Les in barva macesen, RL 200
Prijemalo 316 689

68	Ud (Wm ² /K)
H	1,3*



H 68

HCG 051

Les in barva macesen, RL 22
Steklo ornametno steklo
Kljuka 316 894

68	Ud (Wm ² /K)
H	1,3 (Ug 0,7)
H	1,4 (Ug 1,1)



H 68

HCG 052

Les in barva meranti, RM 32
Steklo ornametno steklo
Kljuka 316 722

68	Ud (Wm ² /K)
H	1,3 (Ug 0,7)
H	1,4 (Ug 1,1)

LES IN LESENI PROFILI

- ☐ Uporabljen les ustreza kakovostnim zahtevam standarda EN 942.
- ☐ Vlažnost lesa je kontrolirana in znaša 13 +/- 2 %.
- ☐ Les je skladiščen v prostorih z regulirano zračno vlažnostjo, kar preprečuje pokanje in ostale napake povezane z neustrezno vlažnostjo lesa.
- ☐ Leseni profili okvirja debeline 68, 80 mm ter različne debeline kril.
- ☐ Profili so zlepjeni iz treh slojev z vodoodpornim lepilom skupine D4 po EN 204 in pr EN 14257.
- ☐ V pokončnih krila programa CLASSIC so vgrajeni aluminijasti ali jeklenimi stabilizatorji za preprečevanje zvijanja krila.



VRATNA KRILA

- ☐ Debelina standardnih vratnih kril je 68 mm in 80 mm. Opcija nizkoenergijsko krilo debeline 95 mm in PASIVNO krilo debeline 98 mm.
- ☐ Površina kril je obložena s furnirano vezano ploščo za lazurne premaze ali mdf ploščo za prekrivne barve. Vgrajena je ojačitev iz aluminija ali jekla za večjo stabilnost krila.
- ☐ Sredica iz trde toplotno izolativne PUR pene. Na obeh straneh krila je vgrajena parna zapora iz aluminija.

OKOVJE

- ☐ Kakovostna tridimenzionalno nastavljiva standardna nasadila Baka Protect 4010 3D FD (HH68) in skrita nasadila Tectus TE 540 3D (HH80).
- ☐ 3 ali 5-kratna zapora krila.
- ☐ Različne opcije odpiranja; odpiranje navzven, odpiranje na prstni odtis, električno odpiranje, ...



ZASTEKLITEV

- ☐ Na izbiro imamo široko paleto toplotno in zvočno izolativnih ter varnostnih stekel.
- ☐ Velika izbira ornamentev in vitražev tudi po vaših željah.
- ☐ Dodelava stekla z različnimi folijami, steklenimi dodatki, peskanjem, ...

POVRŠINSKA OBDELAVA

- ☐ S široko paleto premazov za les smo prepričani, da boste lahko našli barvo po svojem okusu.
- ☐ Obloge iz aluminija so prašno lakirane, kar je ekološko prijaznejše in zagotavlja odlično kakovost ter obstojnost obarvane površine.



ODPIRANJA

Odpiranje navznoter, pogled od zunaj



LEVO ODPIRANJE



DESNO ODPIRANJE

TIPI Odpiranje navznoter, pogled od znotraj

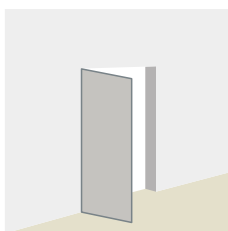

Tip 01

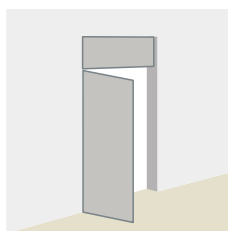

Tip 02

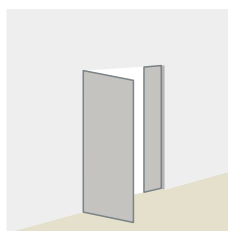

Tip 04

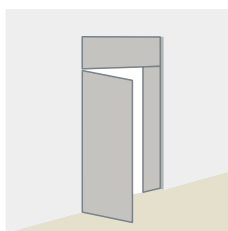

Tip 05

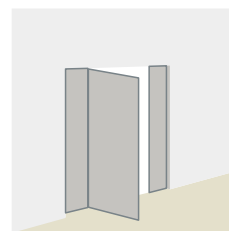

Tip 07

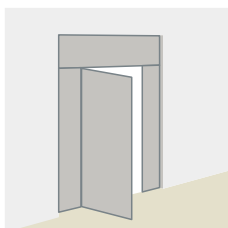

Tip 08

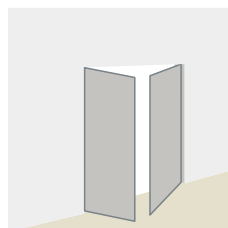

Tip 21

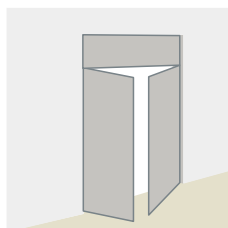

Tip 22

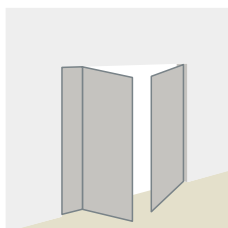

Tip 24

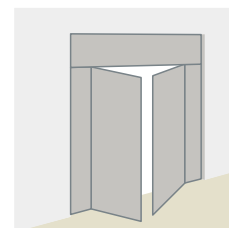

Tip 25

Lesena vrata **zunaj**

model HTR 106B, deb. 68/ 95 mm

poravnana

les in barva: krilo hrast RE 200
okvir Ral 7016



Holz/Alu Fenster **zunaj**

INO-HA80-MM poravnana

INO-HA80-ML poravnana

INO-HA80-F poravnana

barva aluminija: RAL 7016 Fs



Leseno okno **zunaj**

INO-92, INO-80

les in barva: hrast RE 200

BEDIENUNGSKOMFORT



Odpiranje vrat na prstni odtis s čitalcem dLine



Prijemalo z integriranim čitalcem prstnih odtisov dLine



Odpiranje vrat na prstni odtis s čitalcem Idencom



Odpiranje vrat s tipkovnico

Lesena vrata **notranja stran**

Model HTR 106B, deb. 68/95 mm
Les in barva: hrast RE 200

Les/aluminij okno **notranja stran**

INO-HA80-MM *poravnana*
INO-HA80-ML *poravnana*
INO-HA80-F
les in barva: hrast RE 200



Leseno okno **znotraj**

INO-92, INO-80
les in barva: hrast RE 200



LED LUČI



Prijemalo z integrirano
LED osvetlitvijo



LED-Diode

KUKALA

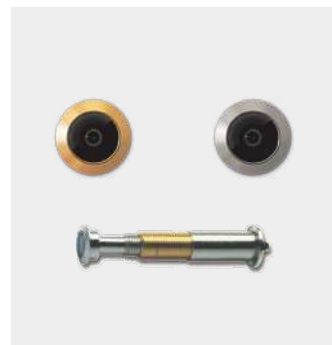

LES/ALUMINIJ VHODNA VRATA INO-HAH

z aluminijasto oblogo

les deb. 80 mm

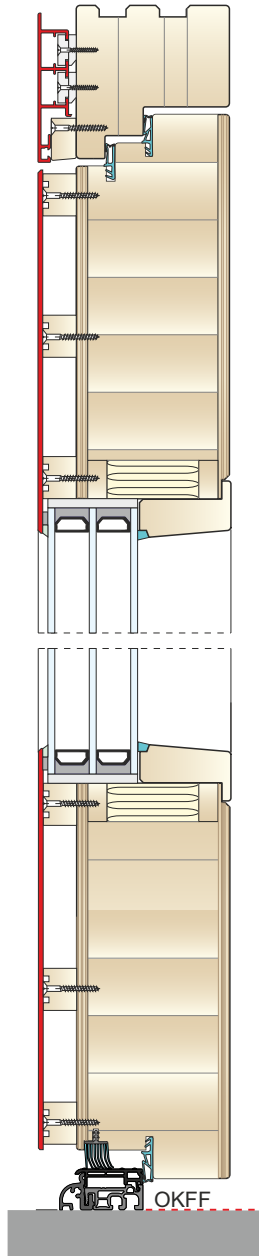

Seriya **TREND ALPHA**

z aluminijasto oblogo

les deb. 68 mm

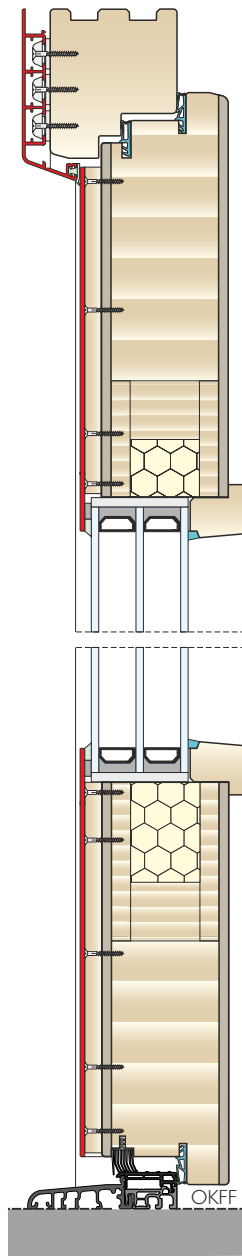

Seriya **TREND MODERN**

z aluminijasto oblogo

les deb. 68 mm

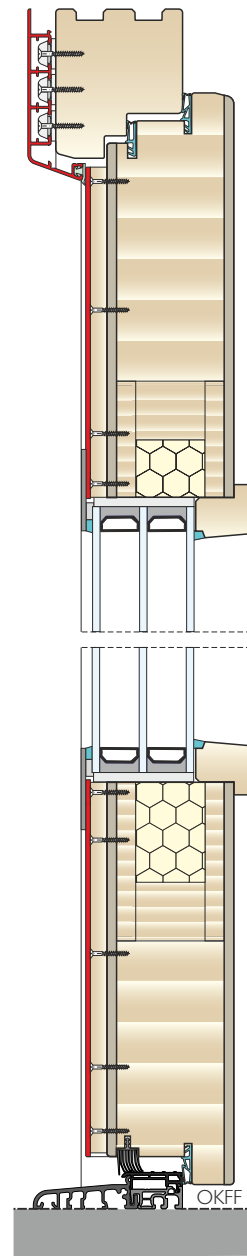

Seriya **DELUXE**

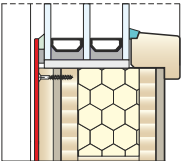
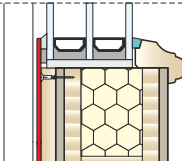
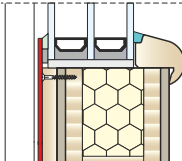
LES DEB. 68 mm	<p>STANDARDNO OGLATA zasteklitvena letvica</p> 	<p>OPCIJA PROFILIRANA zasteklitvena letvica</p> 	<p>OPCIJA ZAobljena zasteklitvena letvica</p> 
----------------	---	--	--

LESENA VHODNA VRATA **INO-HH**

deb. 68/ 68-95 mm

deb. 68/ 68 mm

deb. 68/ 68 mm

deb. 68/ 68 mm

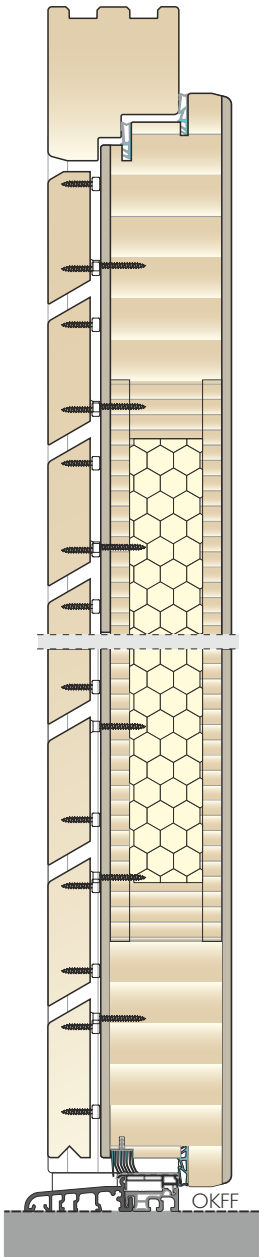

Seriya **TREND LINE**

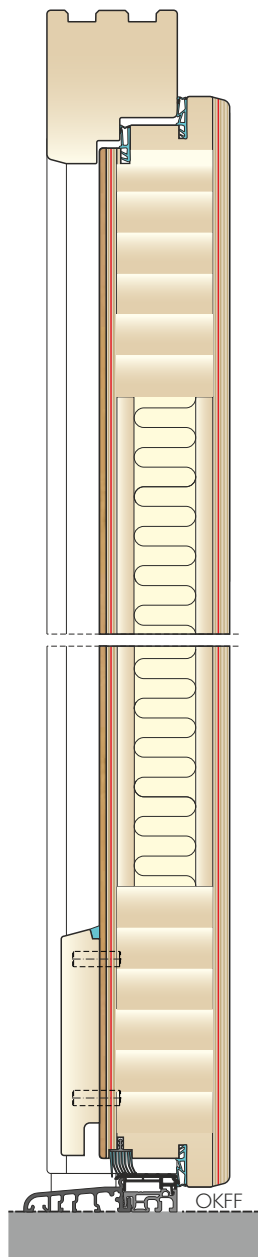

Seriya **TREND HBF**

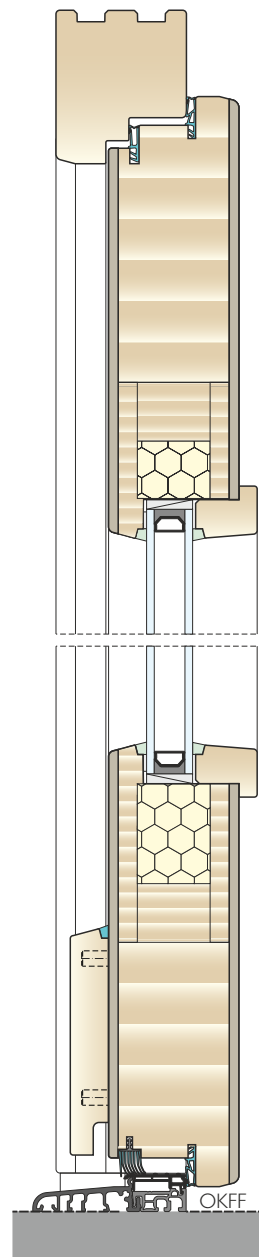

Seriya **TREND**

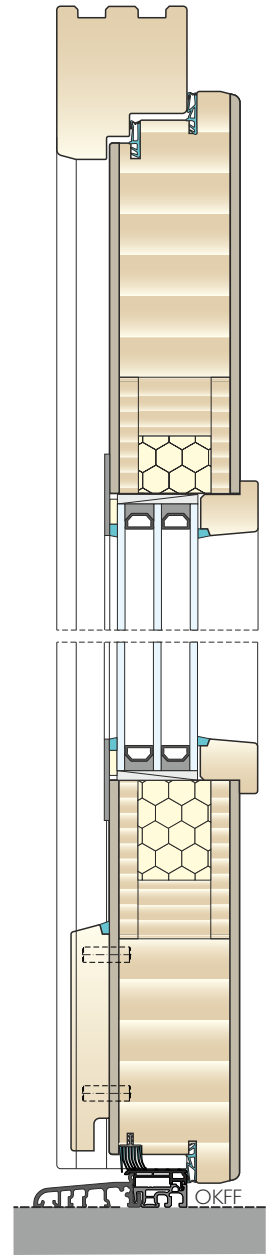

Seriya **DELUXE**

LESENA VHODNA VRATA **INO-HH**

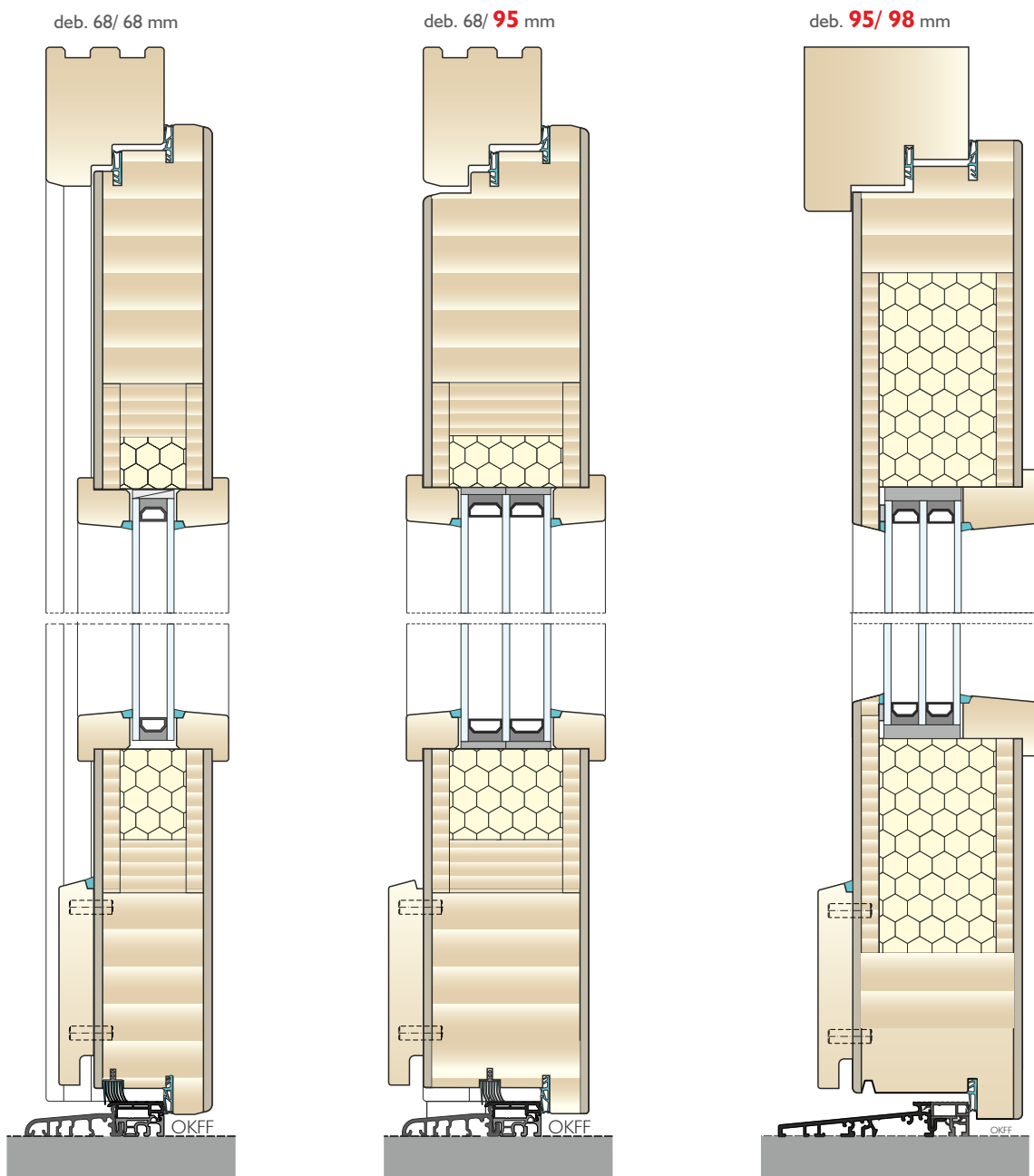

Serija **MODERN**

Model **TREND, HT 100**
Serija **MODERN**

**NIZKO
ENERGIJSKO**

Model **TREND, HT 264**

PASIVNO

LES/ALUMINIJ VHODNA
VRATA **INO-HAH**

masiven les
deb. 68 mm

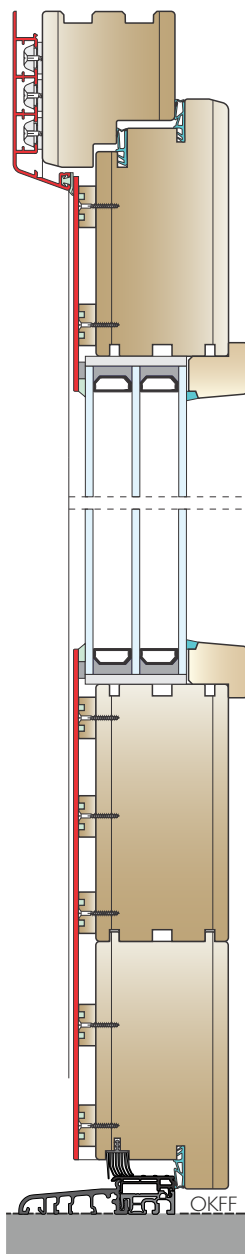

Seriya **KLASSICO**
(zaradi tehničnih razlogov
vsi modeli niso na voljo.)

LESENA VHODNA
VRATA **INO-HH**

masiven les
deb. **80/ 80** mm

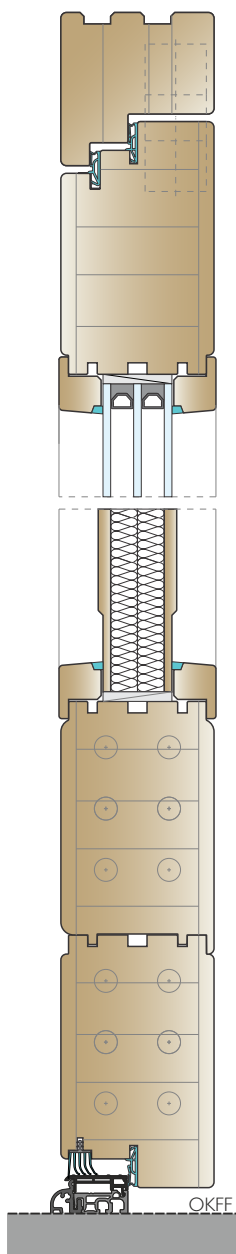

Seriya **KLASSICO ETA**

masiven les
deb. 68/ 68 mm

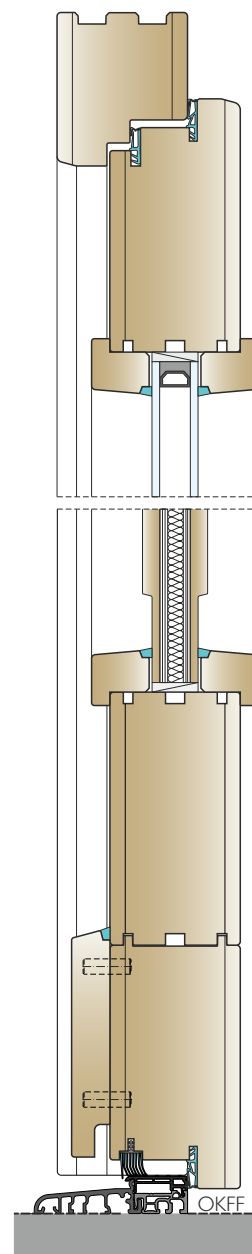

Seriya **ANTICO,
RUSTICO, KLASSICO,
NEOKLASSICO**

LESENA VHODNA VRATA INO-HH

STANDARDNO HH 68
OGLATO (zast. letvica in odkapna letev)
BKV 80 TB pohodni prag

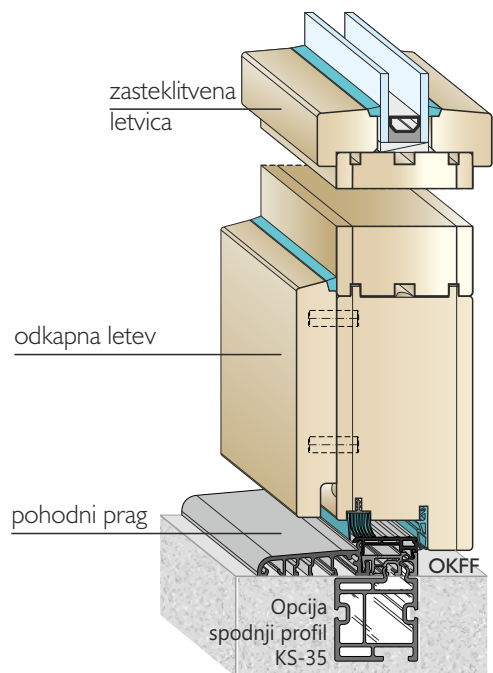

STANDARDNO HH 80
BKV 40 TB pohodni prag

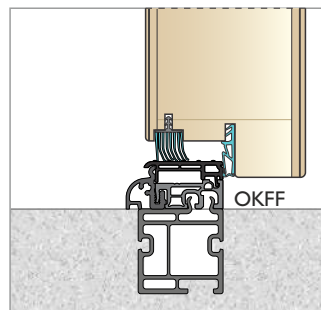

OPCIJA HH 80
BKV 80 TB pohodni prag

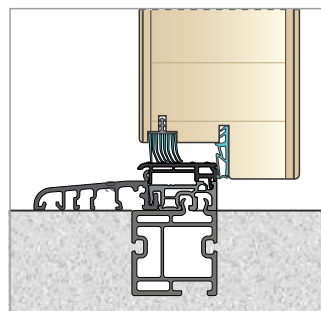

OPCIJA
PROFILIRANO (zastekl. letvica,
odkapna letev)
AV-02 pohodni prag

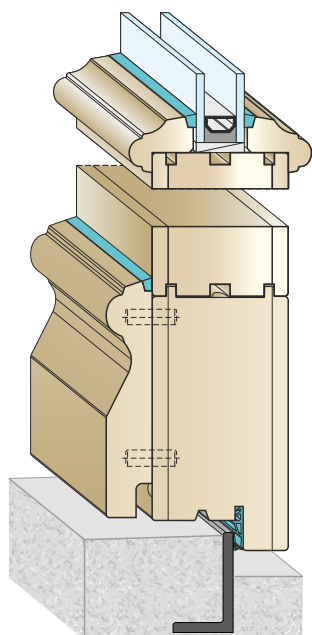

OPCIJA
ZAOKLJENNO (zastekl. letvica,
odkapna letev)
AV-07 pohodni prag

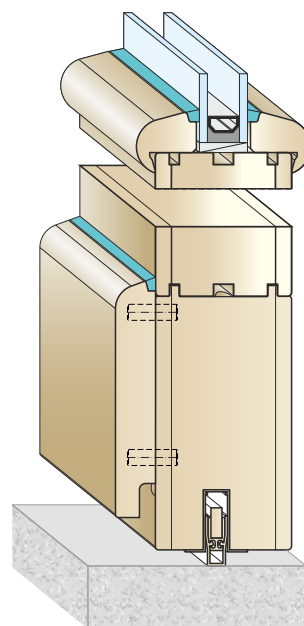



Visoka stopnja varnosti

Poleg visokega standarda kakovosti lesenih in les/aluminij vhodnih vrat, so ta opremljena s 3-točkovnim zaklepanjem kot standardnim zaklepanjem.

Vrata lahko z vidika varnosti nadgradite z certificirano stopnjo varnosti RC2 in jih opremito z elementi za enostavnejšo in bolj praktično uporabo.

1 VARNOSTNI ZATIČI



2 VARNOSTNO STEKLO P4A



3 ENODELNA PRIPIRINA LETEV

4 VARNOSTNI CILINDER Z ZAŠČITO PROTI PREVRTANJU

5 VARNOSTNA GARNITURA



3 NASADILA



BAKA PROTECT 4010 3D FD
- BAND HH 68
trodimenzionalno nastavljiva



TETCUS TE 540 3D
- SKRITA NASADILA HH 80
trodimenzionalno nastavljiva

4 POHODNI PRAGI



BKV 80 TB
HH 68



BKV 40 TB
HH 80

STV-1 (standardno) 3-kratna zapora 2 kavlja

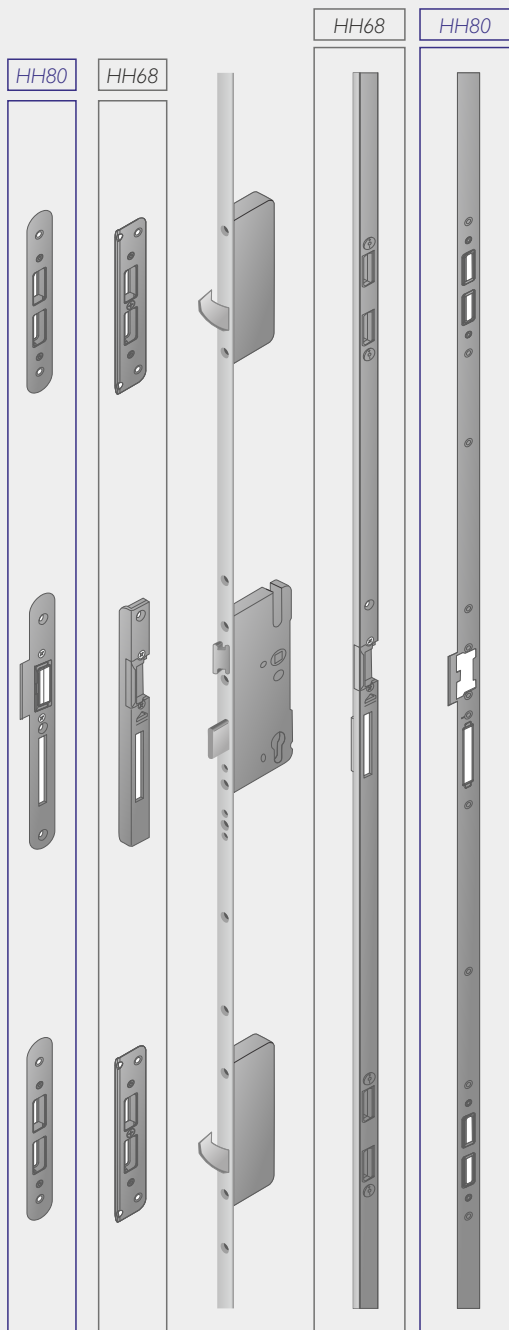

STV-1K MEHANSKA ZAPORA s komfort funkcijo 5-kratna zapora

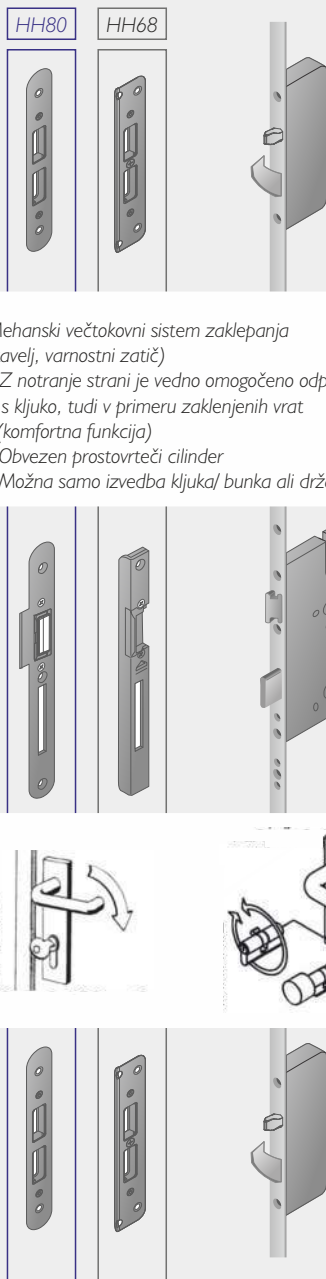

Mehanski večtokovni sistem zaklepanja (kavelj, varnostni zatič)
 - Z notranje strani je vedno omogočeno odpiranje s kljuko, tudi v primeru zaklenjenih vrat (komfortna funkcija)
 - Obvezen prostovrteči cilindar
 - Možna samo izvedba kljuka/ bunka ali držalo/ kljuka

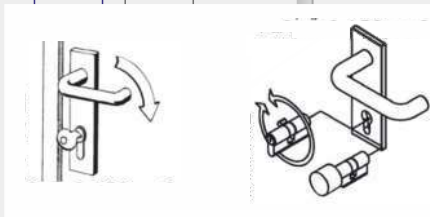

STV-2 5-kratna zapora 4 kavlji

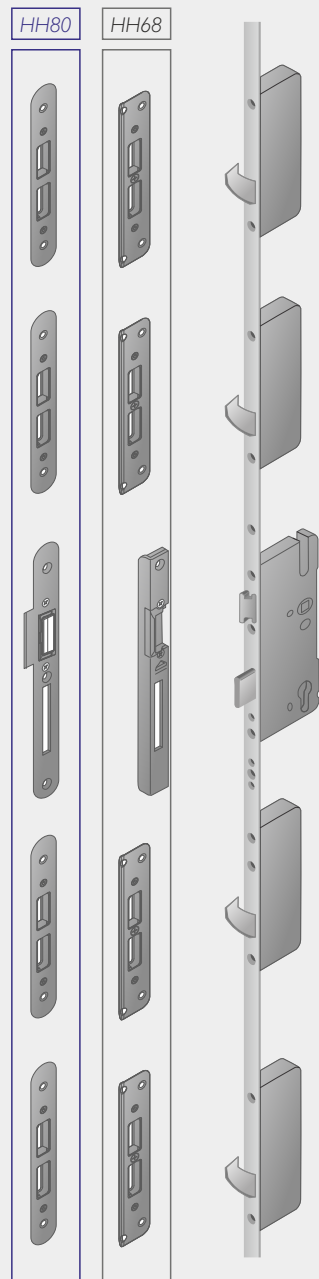

CILINDRIČNI VLOŽKI

KI STANDARD - cilindrični vložek (N+G) z dvostranskim varnostnim delovanjem in s 6 ključi (standardno)



KISK - cilindrični vložek z gumbom na notranji strani in s 6 ključi

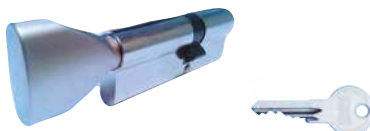

K5 - varnostni cilindrični vložek (N+G) z zaščito proti prevrtanju in s 6 ključi



STV-4

3-kratna zapora
2 avtomatska varnostna zatiča

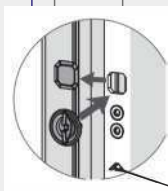
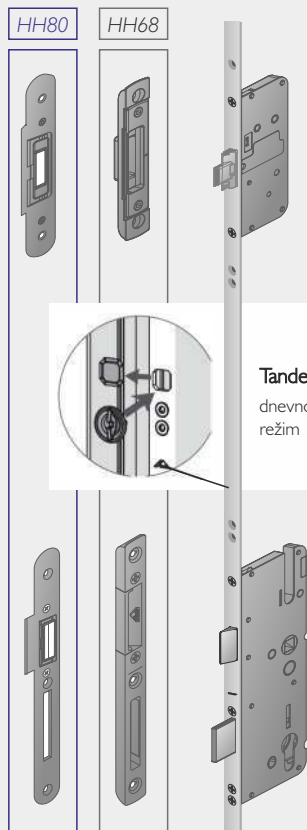

Tandeo
dnevno/nočni režim

STV-4 je mehansko-avtomatski večtočkovni sistem zapiranja, pri katerem se zapirni elementi samodejno pomaknejo v zaprti položaj, takoj, ko se vrata zaprejo. Zahvaljujoč varnosti s certifikatom VdS je ključavnica že zaklenjena brez uporabe ključa. Samodejni sistem zaklepanja je mogoče vklopiti ali izklopiti z naknadno vgradljivim stikalom dan/noč.

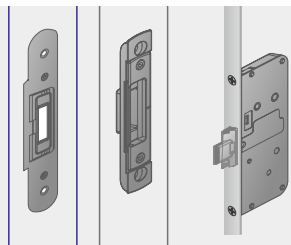

STV-4-M

(E600-Eneo A)
3-kratna zapora
2 avtomatska varnostna zatiča
z motorno funkcijo
vklj. napajanje

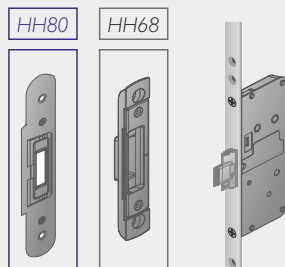

Eneo A je elektromehanski sistem večkratnega zaklepanja, pri katerem se prednosti mehansko-avtomatskega zaklepanja dopolnjujejo s priročnostjo motornega odklepanja in sistemov za nadzor dostopa. Opcijsko je mogoče v motor vgraditi daljinski sprejemnik. Z uporabo ključavnice E600 • Eneo A se vrata zaklenejo mehansko in avtomatsko, kar pomeni, da se dodatne ključavnice samodejno pomaknejo ven, takoj ko vrata padejo v ključavnico. Že brez uporabe ključa velja ključavnica zahvaljujoč VdS certificirani varnosti kot zaklenjena.

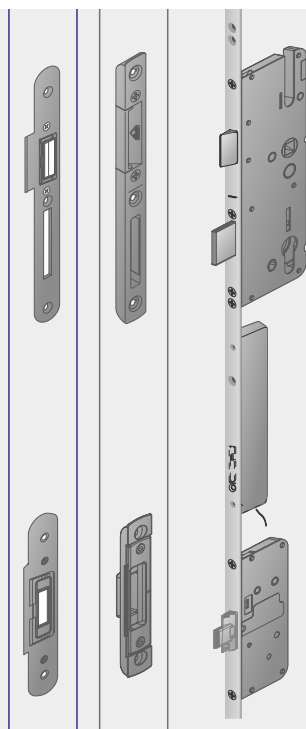

E610-Eneo 2C
5-kratna zapora
vklj. napajanje

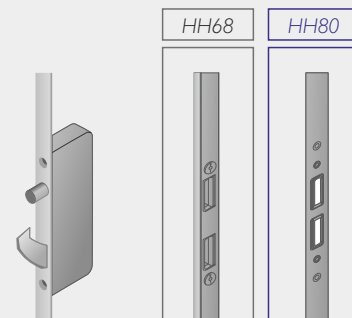

E610 - Eneo 2C je elektromehanski sistem večkratnega zaklepanja, pri katerem se glavna ključavnica in dodatne ključavnice odpirajo in zaklepajo z motorjem. Zahvaljujoč udobnemu odpiranju lahko vhodna vrata vedno odprete od znotraj s pomočjo kljuke, tudi ko so zaklenjena. Hišo lahko vedno varno zapustite, avtomatsko zaklepanje pa nudi zaščito pred vlomom in krajo. Daljinski sprejemnik je serijsko vgrajen v pogonsko enoto. Samodejni sistem zaklepanja je mogoče vklopiti ali izklopiti z naknadno vgradljivim stikalom dan/noč.

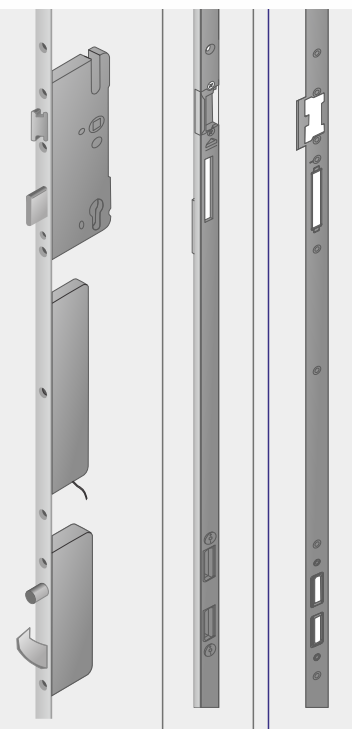

Biometrični način vstopa s prstnim odtisom

Elegantna rešitev, čitalec se lahko vgradi neposredno v vratno krilo ali vratno prijemalo.

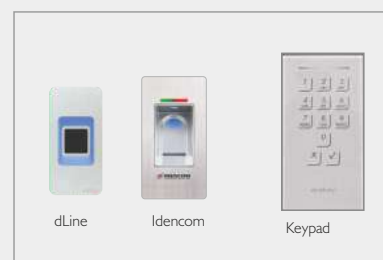

Lesena vhodna vrata **zunanja stran**

Model HT 862A, Serija TREND
 Les in barva: krilo macesen RL 200
 Okvir Ral 7037

HIŠNA ŠTEVILKA KOT
 MOTIV NA STEKLU



ZUNANJE ROZETE

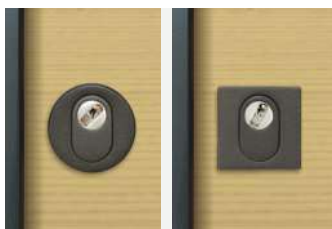

V ČRNI BARVI

PISEMSKI NABIRALNIKI



ODKAPNE LETVE



WSE 03 kot aplikacija iz
 nerjaveče pločevine

Hišna številka iz nerjaveče pločevine



aplikacija iz nerjaveče
 pločevine



WSE 01 iz nerjaveče pločevine



WSE 02 iz nerjaveče pločevine

Lesena vhodna vrata **notranja stran**

Model HT 862A, Serija TREND

Les in barva: macesen RL 200

Vratno zapiralo TS 5000



NOTRANJA PRIJEMALA



NASADILA, GARNITURE KLJUK



Nasadila, notranje kljuke in rozete so barvno skladne.

PRIJEMALA

<p>nerjaveča pločevina mat</p> <p>P 3202 L=350 mm P 3214 L=1500 mm</p> <p>P 3204 L=550 mm P 3216 L=1800 mm</p> <p>P 3206 L=750 mm P 3218 L=2000 mm</p> <p>P 3208 L=950 mm P 3217 L=X mm</p> <p>P 3210 L=1150 mm</p> <p>P 3212 L=1350 mm</p> <p>Schwarz</p> <p>P 3217 L = x</p>	<p>nerjaveča pločevina mat</p> <p>Mit schräger Befestigung</p> <p>316 865 L=400 mm</p> <p>316 866 L=600 mm</p> <p>316 867 L=800 mm</p> <p>316 868 L=1000 mm</p> <p>316 869 L=1200 mm</p> <p>Mit gerader Befestigung</p> <p>316 860 L=400 mm</p> <p>316 861 L=600 mm</p> <p>316 862 L=800 mm</p> <p>316 863 L=1000 mm</p> <p>316 864 L=1200 mm</p>	<p>nerjaveča pločevina mat</p> <p>314 585 L=400 mm</p> <p>314 586 L=800 mm</p> <p>314 597 L=1200 mm</p> <p>314 598 L=1600 mm</p> <p>316 847 L=1800 mm</p> <p>314 599 L=2000 mm</p> <p>videz črnega jekla</p> <p>316 870 L=1000 mm</p> <p>316 871 L=1200 mm</p> <p>316 872 L=1400 mm</p> <p>316 848 L=1600 mm</p> <p>316 849 L=1800 mm</p>	<p>nerjaveča pločevina mat/les</p> <p>SG-180 L=1200 mm</p>	<p>Enerjaveča pločevina mat/les</p> <p>SG-124 L=1200 mm</p> <p>s čitalcem prstnih odtisov</p>	<p>SPSG-17 L=1200 mm</p> <p>Z mini kamero</p>
--	---	---	--	---	---

ZUNANJE ROZETE

nerjaveča pločevina



316 205 316 213 316 214

črna



316 878 316 890 316 890

VARNOSTNE ROZETE



319 062 (68) 316 212 316 211
316 207 (80)

ZAŠČITA PROTI PRASKAM

nerjaveča pločevina



381 112 60 X 75 mm 381 114 55 X 75 mm

s čitalcem prstnih odtisov

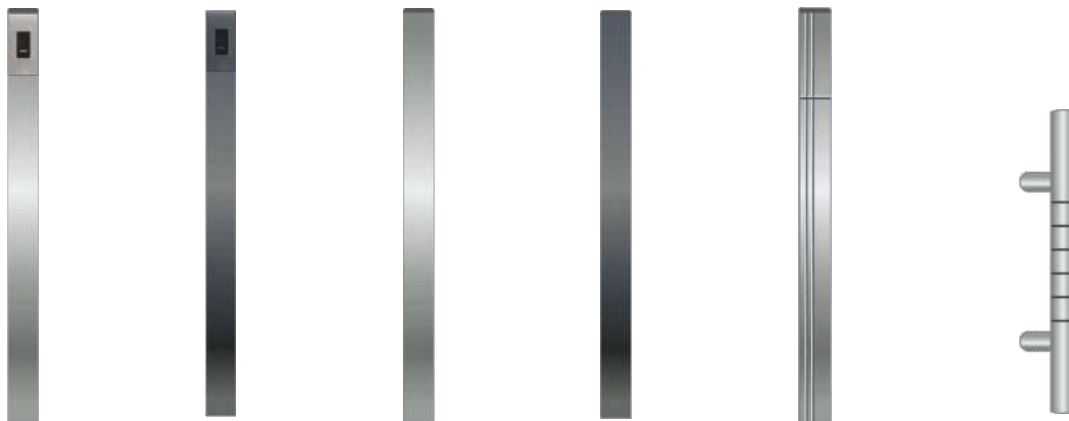

Nerjaveča pločevina mat
P 1182 L=550 mm

črna
P 1182 L=550 mm

Nerjaveča pločevina mat
P 1180 L=550 mm

črna
P 1180 L=550 mm

Nerjaveča pločevina mat
P 1179 L=550 mm

Nerjaveča pločevina
E35303 L=330 mm
E43303 L=400 mm
E63303 L=600 mm



LED-DIODE, barva svetlobe bela, ohišje iz nerjaveče pločevine

- L 1 (57 x 57 mm) ○ L 2 (Ø=41 mm) ● L 4 (Ø=35 mm)
L 3 (Ø=60 mm) ○ L 5 (Ø=30 mm)



Medenina polirana
314 543
L=250 mm

brunirana
314 544
L=250 mm

Medenina polirana
284 744
L=330 mm

Nerjaveča pločevina
mat
284 487
L=380 mm

Nerjaveča pl.
mat
ZAE 66R
L=X mm

Nerjaveča pločevina
mat
P 1176
L=380 mm

Nerjaveča pločevina
mat
P 1177
L=380 mm

PRIJEMALA



SG-48



SG-79



SG-49



SG-83



SG-77



GS-11



GS-21



GS-20



GS-88



GS-74



GS-113

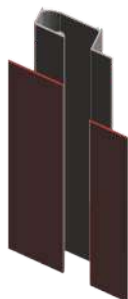

J 137 - ročaj poravnan s krilom

Vtopljen ročaj - v Ral barvi;
Vidna odprtina = 45mm
Dolžina v mm po želji kupca



V 107
L=1400 mm

TRKALA



253 942
medenina - mat krom



253 944
medenina - polirana

NAPISNE PLOŠČICE



NSE I
nerjaveča pločevina



255 506
medenina - polirana



255 510
medenina - polirana

VARNOSTNE GARNITURE



316 254 (L)
316 255 (R)



319 567



314 866



314 839

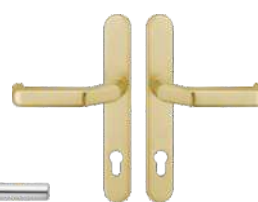

316 242



316 894 (L)
316 895 (R)



316 722

ORNAMENTNA STEKLA

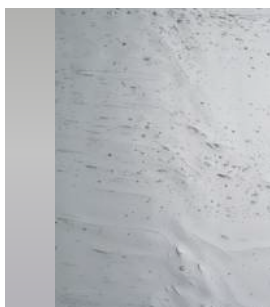

Altd Deutsch belo



Chinchilla belo

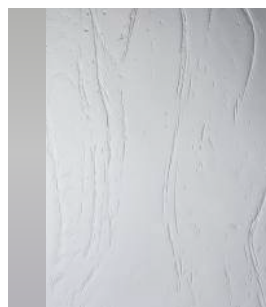

Gothic belo



Altd Deutsch K belo

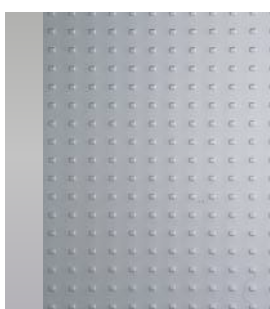

Mastercarre belo



Masterligne belo

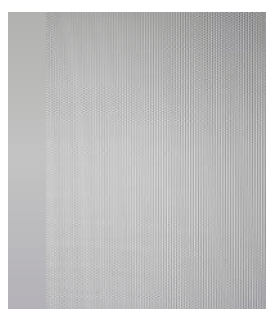

Masterpoint belo



Satinato belo

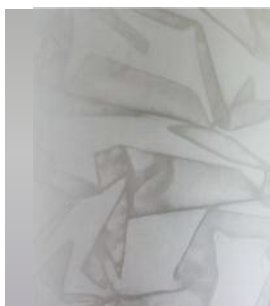

Silk belo

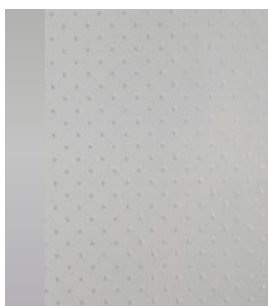

Pave belo

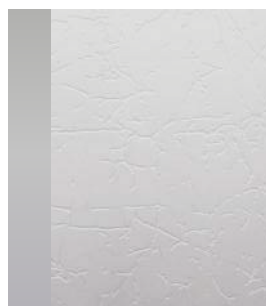

Uadi belo



Nebulosa belo

TOPLOTNO IZOLATIVNA
ZASTEKLITEV

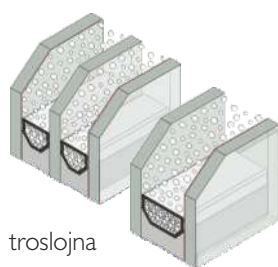

troslojna

dvoslojna

PESKANI MOTIVI



STEKLO Z APLIKACIJO



VITRAŽI



BARVNA KARTA LESENIH POVRŠIN

Za lesena in les/aluminij okna in vhodna vrata

Na razpolago imamo naslednje lesne vrste



smreka



bor



macesen



hrast



meranti

Lazurni premazi (vidna struktura lesa)

Smreka/ bor

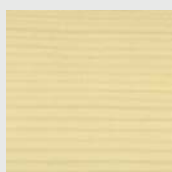

RF 200



RFI ÖI ▼

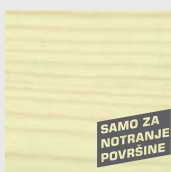

RFI NE



RFI I

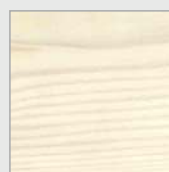

RF/K 10



RFI 10

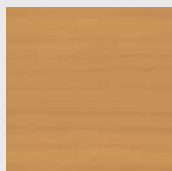

RF/K 11



RF/K 12

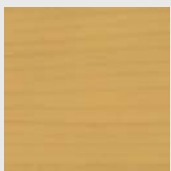

RF/K 19

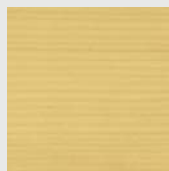

RF/K 21

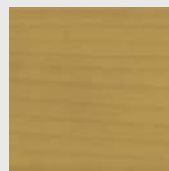

RF/K 22



RF/K 15 *



RF/K 16 *



RF/K 17 *

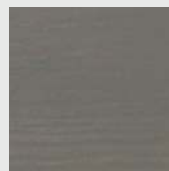

RF/K 26 *

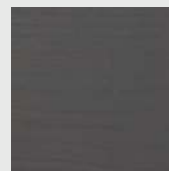

RF/K 27

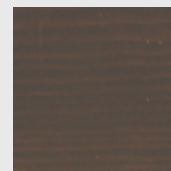

RF/K 25

Bor



RK 1 *



RK 2 *



RK 4 *

Temeljni premaz



RG 1

Macesen



RL 200

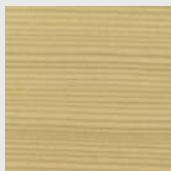

RL ÖI ▼



RLI NE



RLI I

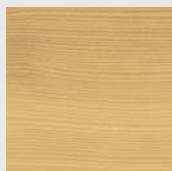

RL 21



RL 22



RL 23

OKOLJU PRIJAZNO

Za naš troslojni sistem površinske obdelave izdelkov uporabljamo okolju prijazne premaze na vodni osnovi.

Za lesena in les/aluminij okna in vhodna vrata

Hrast

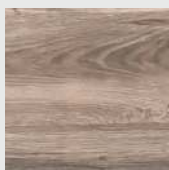

ALTHOLZ

NOVO

LESNI DEKOR ALTHOLZ

Možen za dva modela: HT 100, HTA 100

Površinska obdelava: surovo, oljeno ali grundirano

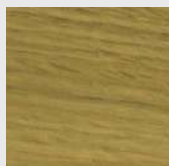

RE 200

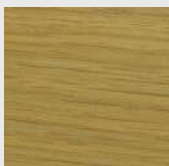

RE Ö1 ▼



REI NE

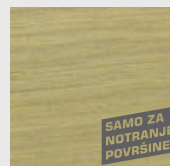

REI I

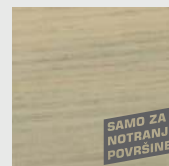

REI 10

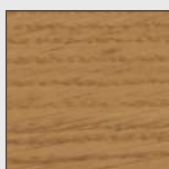

RE 21

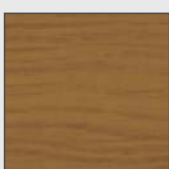

RE 22

Meranti



RM 21



RM 22



RM 23

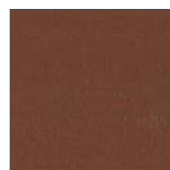

RM 24



RM 25

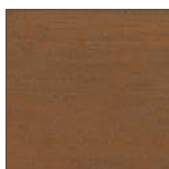

RM 30



RM 31



RM 32

POKRIVNE BARVE (ostale pokrivne barve po RAL barvni karti)

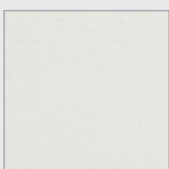

R D 21



R D 22



R D 25

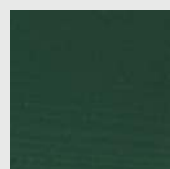

R D 44

Razlaga in opozorilo:

▼ **OLJENO** Na oljeno površinsko obdelavo, Inles ne daje nobene garancije. Take izdelke je potrebno vsaj 2x letno premazati z ustreznim oljem, ki ga lahko kupite pri nas.

✳ **BARVE RF/K 15, RF/K 16, RF/K 17, RF/K 26 in RK 1, RK 2, RK 4**

Ti odtenki močno poudarjajo lesno strukturo in so zato bolj občutljivi na morebitne barvne razlike in različna obarvanja, ki so lahko posledica različnih struktur lesa, vstavljenih smolnic za popravilo žepov s smolo in drugih značilnosti, povezanih s standardnimi tehnološkimi postopki za strojno in površinsko obdelavo lesa. Les je naraven izdelek, zato se po takšni površinski obdelavi z bolj pigmentirano temeljno barvo zaradi različne vpojnosti lesa, kot posledica njegove edinstvene oblike in strukture, ustvari igriva kombinacija barvnih odtenkov. Ker je les naraven proizvod, to ne pomeni, da se zaradi tega njegova kakovost zmanjša ali, da so takšne barvne razlike lahko vzrok za reklamacijo lesenih izdelkov.

BARVE

Ponudba barv za aluminijaste površine
IZBOR

MASTER COLLECTION

(strukturne, metalik)



Night Grey
Feinstruktur Metallic



Cast Iron
Feinstruktur Metallic



Russet Copper
Feinstruktur Metallic



Brown
Feinstruktur Metallic



Verdigris
Feinstruktur Metallic



Granit Nature
Feinstruktur Metallic



Volcanic Ash
Feinstruktur Metallic



Elves Bench
Feinstruktur Metallic

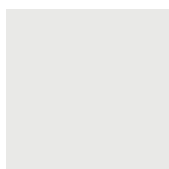

Artic Ice
Feinstruktur Metallic



Precious Sand
Feinstruktur Metallic



Iceberg Blue
Feinstruktur Metallic



Rumbling Sky
Feinstruktur Metallic

ANODIZING COLLECTION

(mat, metalik)

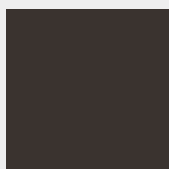

CARBON NIGHT
Matt Metallic



DARK COPPER
Matt Metallic



SIMPLY COPPER
Matt Metallic



GREY BD
Matt Metallic

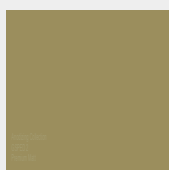

GSPED 2
Matt



GSPED 3
Matt



GSPED 4
Matt



NOBLE BRONZE
Matt Metallic

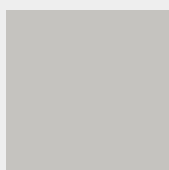

GSPED 0
Matt



GSPED 1
Matt



ORIGINAL PLATINIUM
Matt Metallic

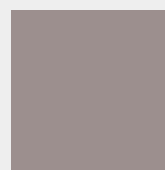

SILVER DREAM
Matt Metallic

DEKOR - VIDEZ KAMNA **NOVO**

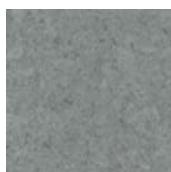

Dekor Zement hell



Dekor Beton dunkel

LESNI DEKOR **NOVO**

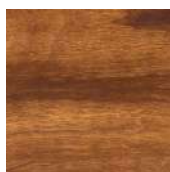

Dekor Altholz



Dekor Stadelholz grau

RAL BARVE

(mat, strukturne, metalik, gladke)

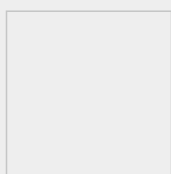

RAL 9016
Matt/ Feinstruktur

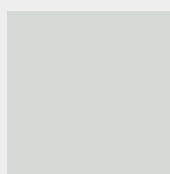

RAL 7035
Matt/ Feinstruktur

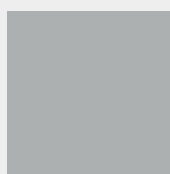

RAL 7004
Matt/ Feinstruktur

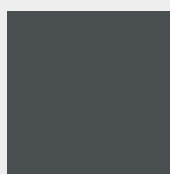

RAL 7016
Matt/ Feinstruktur



6768 BRAUN
Feinstruktur

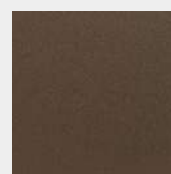

Rostiges eisen
Feinstruktur

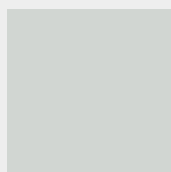

RAL 9006
Metallic glatt



RAL 9007
Metallic glatt



DB 703
Metallic glatt



DB 703
Metallic Feinstruktur



RAL 8017
Matt/ Feinstruktur



RAL 5014
Matt/ Feinstruktur

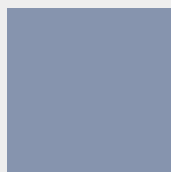

RAL 5014
Matt/ Feinstruktur

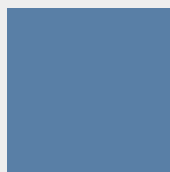

RAL 5007
Matt/ Feinstruktur

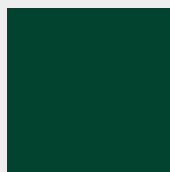

RAL 6005
Matt/ Feinstruktur

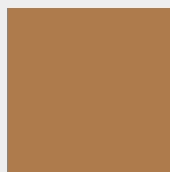

RAL 8001
Matt/ Feinstruktur



RAL 8003
Matt/ Feinstruktur

Lesni dekorji



Douglas 2

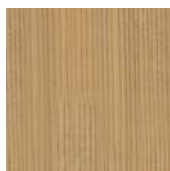

Douglas 6



Douglas 7



Eiche dunkel



Kirsch 2

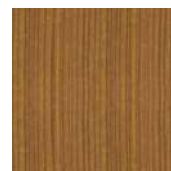

Kirsch 3

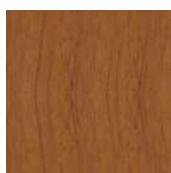

Eiche 4

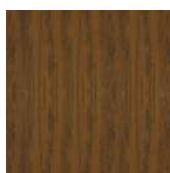

Eiche 2



Golden Oak

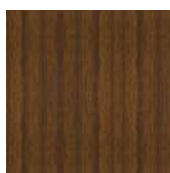

Nuss I

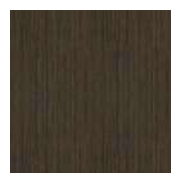

Wenge

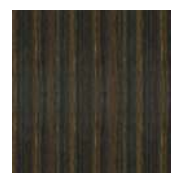

Walnuss dunkel

TREND ALPHA
HTA



HTA 100 - stran 9



HTA 103 - stran 12



HTA 105 - stran 12



HTA 121 - stran 13



HTA 123 - stran 13



HTA 131 - stran 17



HTA 153A - stran 31



HTA 251A - stran 20



HTA 258 - stran 25



HTA 258A - stran 25



HTA 264 - stran 14



HTA 264A (slika na strani 14
v izvedbi 68)



HTA 265
(slika na strani 22 v izvedbi 68)



HTA 265A - stran 22



HTA 806 (slika na strani 24
v izvedbi 68)



HTA 810 - stran 24



HTA 843 (slika na strani 20
v izvedbi 68)



HTA 845 (slika na strani 26
v izvedbi 68)



HTA 862A (slika na strani 19
v izvedbi 68)



HTA 863A (slika na strani 17
v izvedbi 68)



HTA 863B - stran 17



HTA 866 - stran 26



HTA 867 (slika na strani 13
v izvedbi 68)



HTA 872 - stran 21



HTA 874 - stran 15



HTA 883 - stran 31



HTA 885 - stran 30

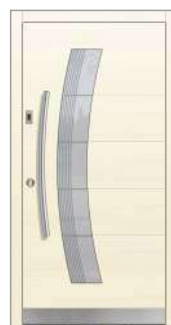

HTA 887B - stran 29



HTA 898A - stran 21



HTA 899 - stran 16



HTA 906A - stran 19



HTA 919 - stran 18



HTA 920A - stran 18



HTA 924A (slika na strani 23
v izvedbi 68)



HTA 934 - stran 27



HTA 934A - stran 27



HTA 944 - stran 23



HTA 946A - stran 23

TREND
HT



HT 100 - stran 11



HT 121 (slika na strani 13
v izvedbi 80)



HT 123 (slika na strani 13
v izvedbi 80)



HT 131 (slika na strani 17
v izvedbi 80)



HT 137 - stran 28



HT 153A (slika na strani 31
v izvedbi 80)



HT 251A (slika na strani 20
v izvedbi 80)



HT 255/HSTT 400 - stran 31



HT 258 (slika na strani 25
v izvedbi 80)

PREGLED MODELOV



HT 258A (slika na strani 25 v izvedbi 80)



HT 264 (Bild auf der stran 14 v izvedbi 80)



HT 264A / HSTT 400 - stran 14



HT 265 / HSTT 400 - stran 22



HT 265A (slika na strani 22 v izvedbi 80)



HT 806 / HSTT 400 - stran 24



HT 810 (slika na strani 24 v izvedbi 80)



HT 835 / HSTT 400 - stran 25



HT 843 / HSTT 400 - stran 20



HT 845 / HSTT 400 - stran 26



HT 849 - stran 28



HT 862A / HSTT 400 - stran 19



HT 863A / HSTT 400 - stran 17



HT 863B (slika na strani 17 v izvedbi 80)



HT 864 / HSTT 400 - stran 15



HT 866 (slika na strani 26 v izvedbi 80)



HT 867 / HSTT 400 - stran 13



HT 872 (slika na strani 21 v izvedbi 80)



HT 874 (slika na strani 15 v izvedbi 80)



HT 875 - stran 15



HT 883 (slika na strani 31 v izvedbi 80)



HT 885 (slika na strani 30
v izvedbi 80)



HT 885A/ HSTT 400 - stran 30



HT 887A/ HSTT 400 - stran 29



HT 887B (slika na strani 29
v izvedbi 80)



HT 894 - stran 29



HT 898A (slika na strani 21
v izvedbi 80)



HT 899 (slika na strani 16
v izvedbi 80)



HT 900/ HSTT 400 - stran 18



HT 906 - stran 19



HT 906A (slika na strani 19
v izvedbi 80)



HT 909/ HSTT 400 - stran 21



HT 911/ HSTT 400 - stran 16



HT 919 (slika na strani 18
v izvedbi 80)



HT 920A (slika na strani 18
v izvedbi 80)



HT 924A/ HSTT 400- stran 23



HT 934 (slika na strani 27
v izvedbi 80)



HT 934A (slika na strani 27
v izvedbi 80)



HT 944 (slika na strani 23
v izvedbi 80)



HT 946A (slika na strani 23
v izvedbi 80)



HT 947/ HSTT 400 - stran 27

TREND RUSTICO
HTR



HTR 102A- stran 34



HTR 103 - stran 35



HTR 103A - stran 34



HTR 105 - stran 35



HTR 106A - stran 35



HTR 106B/ HSTT 400- stran 33



HTR 107 - stran 33

TREND LINE
HTL



HTL 100/ HSTT 400 - stran 37



HTL 103 - stran 38



HTL 105 - stran 39



HTL 268 - stran 37



HTL 269 - stran 39



HTL 270 - stran 39



HTL 272 - stran 38

TREND
HBF



HBF 123 - stran 43



HBF 266B - stran 42



HBF 845/ HSTT 400 - stran 43



HBF 894 - stran 41



HBF 906- stran 43



HBF 911A/ HSTT 400- stran 42

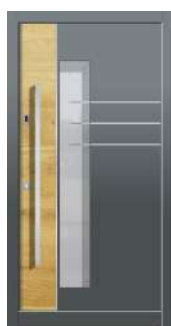

HBF 919A - stran 41

DELUXE
HD



HD 168 - stran 46



HD 801A/ HSTT 400
- stran 46



HD 852A - stran 45



HD 875C - stran 47



HD 945/ HSTT 400 - stran 47



HD 945 - stran 47

MODERN
HM



HM 131- stran 52



HM 132A - stran 53



HM 133A- stran 52



HM 134B - stran 50



HM 170 - stran 53



HM 172C - stran 49



HM 180 - stran 51



HM 222 - stran 50



HM 875C- stran 51

NIZKO
ENERGIJSKO
& PASIVNO



HT 100 - stran 54



HT 264 - stran 55

TREND NOVO
HTN



HTN 101 - stran 58



HTN 102 - stran 57



HTN 102 - stran 57



HTN 103 - stran 58



HTN 103 - stran 59



HTN 104 - stran 59

KLASSICO ETA
HCKE



HCKE 400 - stran 61



HCKE 401 - stran 62



HCKE 401P - stran 62



HCKE 402 - stran 61



HCKE 407 - stran 63



HCGE 051 - stran 63



Oblikujte si svoja vrata s pomočjo konfiguratorja na naši spletni strani:
<https://inles.door-konfigurator.com/>

KLASSICO
HCK



HCK 400 - stran 65



HCK 401 - stran 66



HCK 402 - stran 72



HCK 403 - stran 66



HCK 404/HSTC 400 - stran 67



HCK 405 - stran 67



HCK 406 - stran 67



HCK 407 - stran 68



HCK 408 - stran 68



HCK 409 - stran 69



HCK 410 - stran 71



HCK 411 - stran 73



HCK 413/HSTC 413A - stran 73



HCK 415 - stran 73



HCK 417 - stran 69



HCK 418 - stran 65



HCK 419 / OL 101 - stran 71



HCK 420 - stran 70



HCK 422 - stran 70

PREGLED MODELOV



HCK 424/HSTC 400 - stran 69



HCK 425 - stran 71



HCK 427 - stran 72

ANTICO
HCA



HCA 601 - stran 77



HCA 602 - stran 77



HCA 603 - stran 76



HCA 605 - stran 75



HCA 607 - stran 77



HCA 610 - stran 76



HCA 611 - stran 76



HCA 612 - stran 75

RUSTICO
HCR



HCR 501 - stran 83



HCR 502 - stran 80



HCR 503 - stran 83



HCR 504 - stran 82



HCR 507 - stran 81



HCR 514 - stran 85



HCR 515 - stran 85



HCR 517 - stran 85



HCR 525 - stran 84



HCR 530 - stran 84



HCR 534 - stran 80



HCR 535 - stran 82



HCR 539 - stran 81



HCR 544 - stran 79



HCR 545 - stran 79

NEOKLASSICO
HCN



HCN 706 - stran 88



HCN 708 - stran 90



HCN 709 - stran 92



HCN 711 - stran 87



HCN 713 - stran 90



HCN 714 - stran 91



HCN 722 - stran 87



HCN 727 - stran 91



HCN 728 - stran 90



HCN 729 - stran 89



HCN 730 - stran 92



HCN 731 - stran 89



HCN 739 - stran 88



HCN 741 - stran 89



HCN 742 - stran 91

STRANSKA
VRATA



HCG 050 - stran 93



HCG 051 - stran 93



HCG 052 - stran 93



Inles

Proizvodnja, trženje in inženiring d.d.

SI - 1310 Ribnica, Kolodvorska 22
tel.: 01 8377 100, fax: 01 8377 333
e-mail: info@inles.si

RAZSTAVNO PRODAJNI SALON RIBNICA
tel.: 01 8377 162, 01 8377 308, 01 8377 289

www.inles.si

POOBlašČENI PRODAJALEC: